

OPERATING MANUAL

MU 7061 EN G

ELECTRONIC CALCULATOR-INDICATING DEVICE UNI

As a part of measuring systems for measurement of liquids other than water



G	2017/10/30	Update table of alarms [MDV568] GU 7110 cancels and replaces FM 8012 [MDV544]	DSM	XS
F	2016/06/14	Volume and flowrate accuracy, time-out for automatic recording, 3-decimals display, season setting in metrological mode	DSM	DRA
E	2015/10/21	MPLS	DSM	AH
C	2013/08/29	Creation	DSM	AH
Issue	Date	Nature of modifications	Written by	Approved by

	MU 7061 EN G ELECTRONIC CALCULATOR-INDICATING DEVICE UNI	Page 1/24
	This document is available at www.alma-alma.fr	

CONTENTS

1	GENERAL PRESENTATION AND DESCRIPTION	4
2	USER RECOMMENDATIONS	5
3	OPERATION	5
4	USER MODE	6
4.1	Menu METERING – MEtErin	7
4.1.1	Non-interruptible measuring system (calculator UNI alone).....	7
4.1.2	Interruptible measuring system (calculator UNI associated to the MPLS)	8
4.1.3	Visualisation of values during delivery.....	9
4.1.4	Data recording and volume reset	9
4.1.5	Printing of a delivery ticket	9
4.1.6	Transfer the measurement results to a computer – option	9
4.2	Menu VISUALISATION – ViSuALi	10
4.2.1	Sub-menu METERING – MEtErin.....	10
4.2.2	Sub-menu TOTALISER – totALiS	10
4.2.3	Sub-menu MEMORISATION – MEMoriS	11
4.3	Menu SUPERVISOR – SuPErVi	12
4.3.1	Sub-menu CALIBRATION – CALibrA.....	12
4.3.2	Sub-menu SEASON – SEASon	12
4.3.3	Sub-menu PARAMETERS – PARAMet.....	13
4.3.4	Sub-menu MAINTENANCE – MAintEn.....	14
4.3.5	Sub-menu TRANSFERT – trAnSFr	14
4.4	List of alarms	15
5	METROLOGICAL MODE	16
5.1	Menu REFERENCE – rEFErEn	16
5.2	Menu TURBINE – turbinE	16
5.3	Menu SCALE – ScALE	17
5.4	Menu COEFFICIENT – CoEFFiC	18
5.5	Menu PRODUCTS – Product	19
5.6	Menu FLOWRATES – FLoWrAt	19
5.7	Menu VOLUMES – VoLuMES	19
5.8	Menu TEMPERATURE – tEMPErA	20
5.9	Menu GAS SENSORS – SEnSorS	20
5.10	Menu THRESHOLDS – V_tHrES	20
5.11	Menu DATE AND TIME – dAt_tIM	21

5.12	Menu AUTOMATIC RECORDING – Aut SAV	21
5.13	Menu MPLS – MPLS	22
ANNEX	23
RELATED DOCUMENTS	24

1 GENERAL PRESENTATION AND DESCRIPTION

The ALMA UNI electronic calculator-indicator is intended to be used as a part of measuring systems for measurement of liquids other than water. Used alone it's a non-interruptible calculator belonging to accuracy classes 0.5 or 1. Associated to the MPLS device, it's an interruptible calculator. It can be autonomous or associated to other devices such as MPLS or CTD+ key.

It can be installed in measuring systems mounted on tank trucks or on a loading terminal.

It can be installed directly on an ALMA ADRIANE turbine measuring device or in an independent case, then it is connected to an ALMA 2B00 pulse emitter.

When necessary, the ALMA UNI electronic calculator-indicator includes:

- ⇒ A 3-wires PT100 temperature sensor (example CT1001),
- ⇒ One or two ALMA gas detectors type Honeywell LLE105000 or DLA01.

Associated to a 2B00-pulse emitter and a kit VAF, the whole is a dye meter.

The UNI electronic calculator-indicator is equipped with a wireless digital connection used to enable the control of the process associated with the measuring system; function performed by the pair UNI/MPLS.

In the case of an ALMA UNI electronic calculator-indicator within an interruptible measuring system, the wireless digital connection enables to preset the volume and to command the pouring to stop when there is a significant failure.

In option, this wireless digital connection may also be used to communicate with a CTD+ key for transferring measuring results and parameters to a PC through USB cable. **CAUTION: the key is not an ATEX device.**

The ALMA UNI electronic calculator-indicator guarantees the metering operations and manages alarms from the measuring system.

The accuracy and the unit of volume and flow rate can be set in METROLOGICAL mode.

The operating temperature for the UNI is between -20°C and +50°C.

On its front face, the UNI device has a LCD backlight protected by a glass to display measurement information which can be read from the user interface. The five buttons have the following functions:



BP5 Light the display during 10 seconds



BP4 Normal mode: return to previous menu
METROLOGICAL mode: increment the flashing figure when imputing a value or return to previous menu



BP3 Normal mode, metering off: select the menu
Normal mode, metering on: display the values (immediate flow, temperature)
Metrological mode: select the figure to be modified or select the menu



BP2 Normal mode: validate the selected menu or value
Metrological mode: validate the displayed value or the selected menu
In case of default: acknowledge the default

	MU 7061 EN G ELECTRONIC CALCULATOR-INDICATING DEVICE UNI	Page 4/24
	This document is available at www.alma-alma.fr	



BP1 The key is active when the UNI is autonomous. Reset the volume to zero and record the data of the last measurement

2 USER RECOMMENDATIONS

When it is not used, it's better to close the UNI cover.

The front face glass must be regularly cleaned for easy readability and better communication with the CTD+ key.

Since the CTD+ key is not ATEX, it must be used outside potentially explosive area.

The UNI device is powered by 2 batteries. The display 'bAttErY' indicates that the batteries must be changed. Batteries must be changed in a non-explosive area. The verification seals have to be broken by authorised personnel only.

Refer to the maintenance sheet FM 8009 about replacement of batteries.

3 OPERATION

The ALMA UNI electronic calculator-indicator performs the following functions:

- ⇒ It ensures the acquisition and processing of the pulses from the pulse emitter or from the electronic card's coils.
- ⇒ It calculates and displays volume in metering conditions based on Kfactor determined during the calibration of the turbine, corrected during the calibration of the measuring system.
In some cases, this volume in metering conditions can be corrected depending on the flow rate and/or the type of liquid measured.
- ⇒ If required, it calculates and displays the mean temperature of the liquid when it is measured by a PT 100 temperature sensor.
- ⇒ If required, it calculates and displays volume converted to base conditions. Volume is calculated by taking into account the mean temperature of the liquid during metering. Using a standard conversion formula, the conversion factor can be calculated according to density in base conditions.
Density is entered manually prior to metering via the METROLOGICAL mode.
- ⇒ The UNI device volume is reset to zero manually.
- ⇒ It memorizes and secures measurement information, which can be read from the user interface of the calculator-indicator.
- ⇒ If the measuring system is interruptible, it presets the volume to be delivered.
- ⇒ It registers accumulated volumes in metering conditions, including when the calculator-indicator is in alarm.

The UNI calculator-indicator has two operation levels: the USER mode for operation: measurement, visualisation, supervision; and the METROLOGICAL mode for the configuration of the device by authorized personnel.

	MU 7061 EN G ELECTRONIC CALCULATOR-INDICATING DEVICE UNI	Page 5/24
	This document is available at www.alma-alma.fr	

4 USER MODE

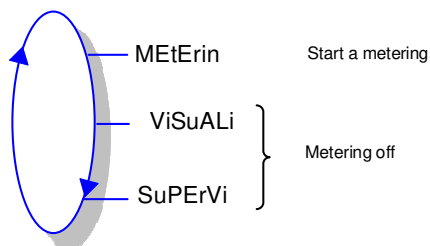

The UNI can be either ON or OFF metering.

The displayed quantity depends on the configuration set in METROLOGICAL mode. The arrow-pictogram located on the right hand of the display screen is used to point out V_m or V_b such as shown below:

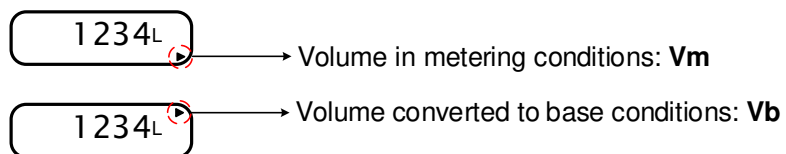

4.1 Menu METERING – MEtErin

4.1.1 Non-interruptible measuring system (calculator UNI alone)

If data recording is not automatic, press RAZ at the end of measurement. The last measurement data is then recorded and the volume is set to zero.

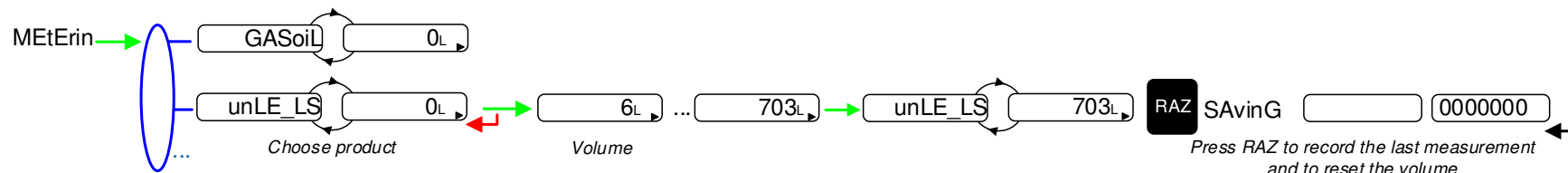

If data recording is automatic, the time required at the end of measurement before recording must be set in METROLOGICAL mode (menu 'Aut SAV').

At the beginning of measurement, appearance of flowrate causes a display test and resets the volume to zero. The last measurement data is recorded at the end of measurement at zero flow and when the time-out is up.

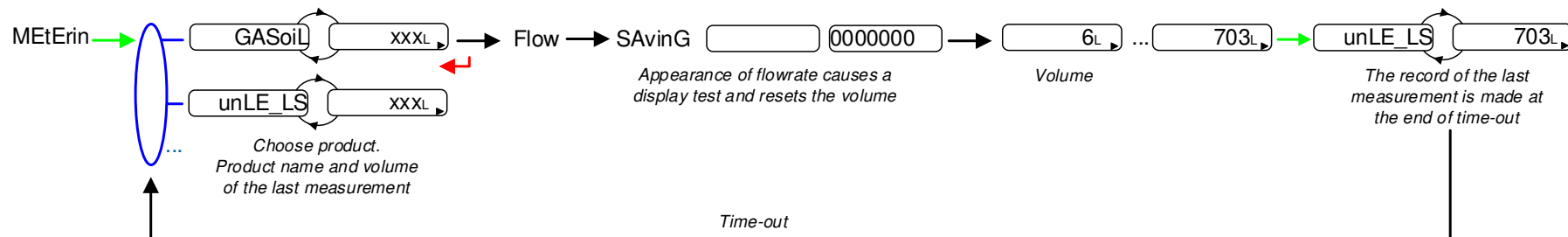

4.1.2 Interruptible measuring system (calculator UNI associated to the MPLS)

Appearance of the authorisation causes a display test and resets the volume. Withdrawal of the authorisation causes recording of the last measurement

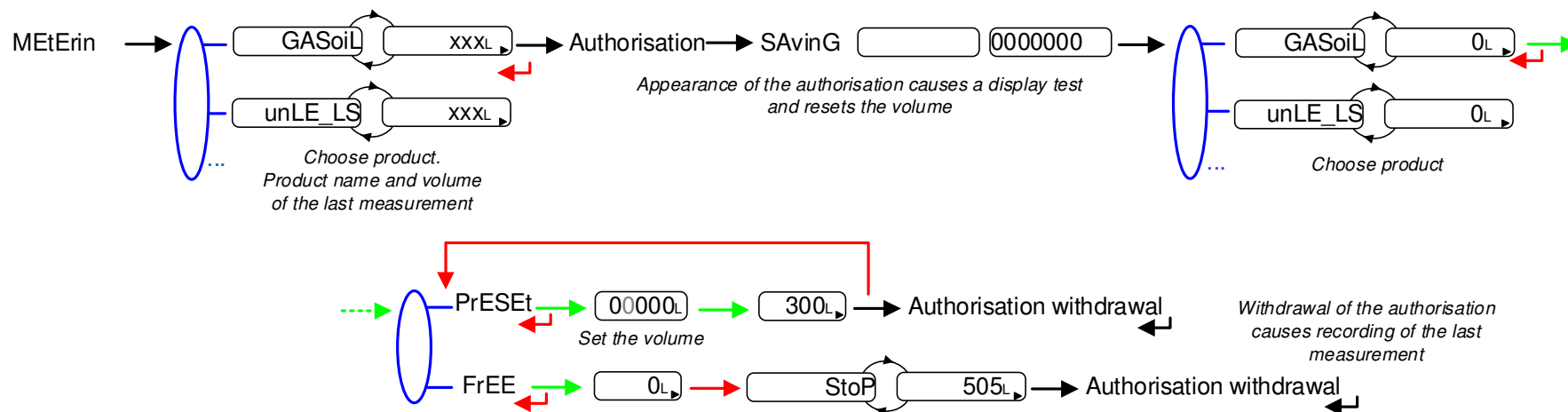

4.1.3 Visualisation of values during delivery

Use BP3 to display flow rate and temperature during measuring (flow>0). Press:

- One time for flow rate,
- Two times for temperature (if the temperature option is activated).

Display returns automatically to the current volume.

4.1.4 Data recording and volume reset

Data recording and volume reset depend on the configuration of the calculator:

For a non-interruptible measuring system:

- Manual recording sequence: volume reset and recording of the last measurement data are triggered by pressing RAZ at zero flow conditions
- Automatic recording sequence: the appearance of flowrate resets the volume to zero. Withdrawal of flowrate causes recording of the last measurement data at zero flow conditions.

For an interruptible measuring system, appearance of the authorisation resets the volume to zero. Withdrawal of the authorisation causes recording of the last measurement at zero flow conditions.

4.1.5 Printing of a delivery ticket

For interruptible measuring systems only.

If a printer is connected to the MPLS device, simply insert a ticket into the printer at the end of measurement and the delivery ticket is printed (see ANNEX).

4.1.6 Transfer the measurement results to a computer – option



Since the CTD+ key is not ATEX, this operation must be done outside potentially explosive area.

The 'CTD+' option allows to transferring parameters and measurements results to the key. Then, data may be downloaded from the key to a PC through USB cable.

The transfer of the measurement results of the N last days is possible when flow rate is zero. N has to be set in SUPERVISOR menu

Refer to the Operating guide GU 7110 about transferring the measurement results of the UNI indicator device to a computer.

4.2 Menu VISUALISATION – ViSuALi

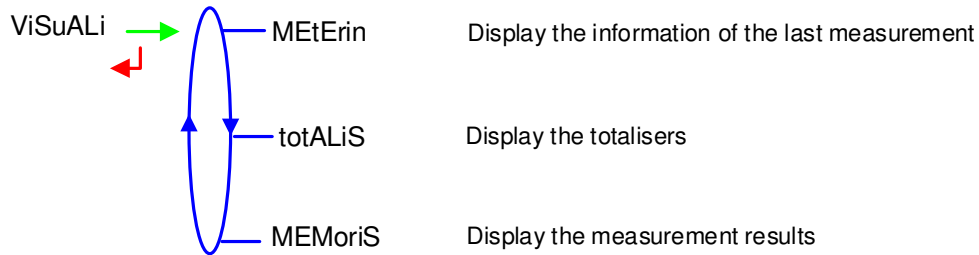

If the values are preceded by this display ‘-----’; it means they are no longer guaranteed.

4.2.1 Sub-menu METERING – MEtErin

This menu displays the information of the last measurement. Information displayed depends on the calculator configuration.

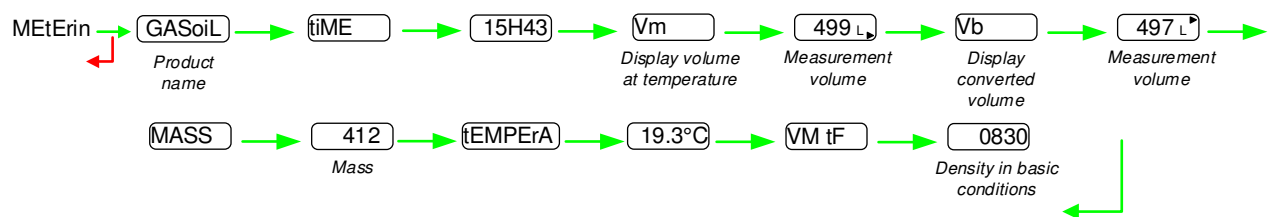

4.2.2 Sub-menu TOTALISER – totALiS

This menu displays:

- The totaliser of volume in metering conditions (Vm)
- The totaliser of volume converted to base conditions (Vb) if the temperature option is activated.

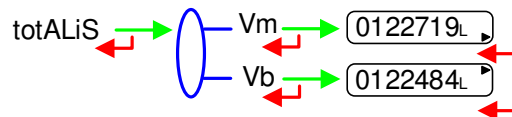

4.2.3 Sub-menu MEMORISATION – MEMoriS

This menu displays the measurements results. Information displayed depends on the calculator configuration. Temperature, converted volume (Vb), and mass are only displayed if the temperature option is activated.

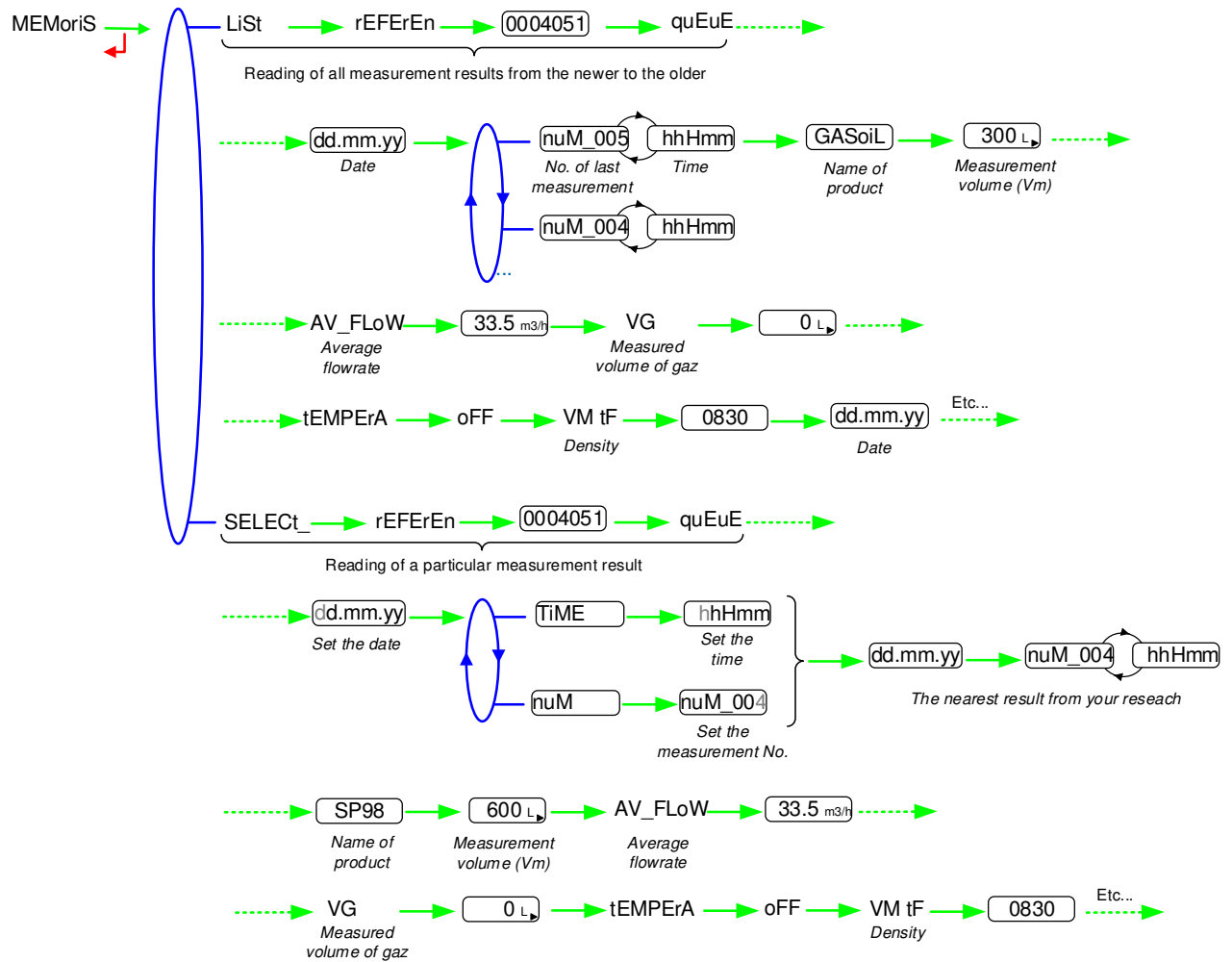

The measured gas volume is displayed for information only, it has no metrological value.

4.3 Menu SUPERVISOR – SuPERVi

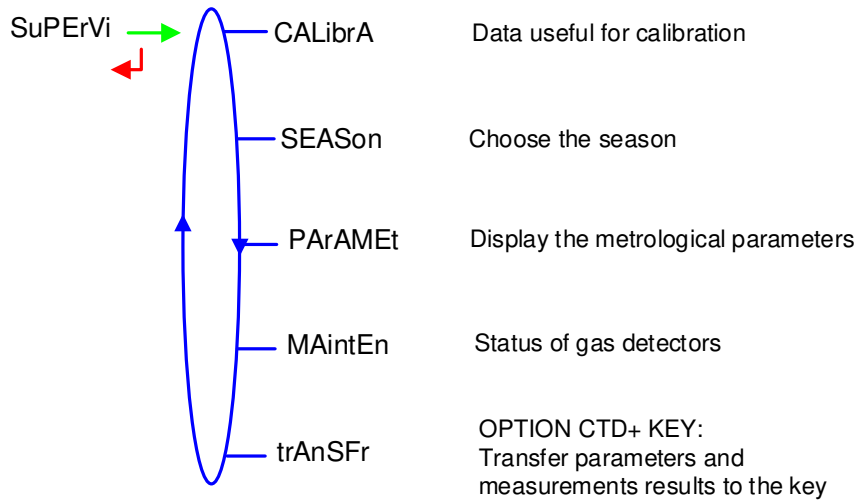

4.3.1 Sub-menu CALIBRATION – CALibrA

Check the measuring system accuracy during the calibration with a gauge. This menu is available after a measurement sequence when the measurement results are recorded (following withdrawal of authorisation).

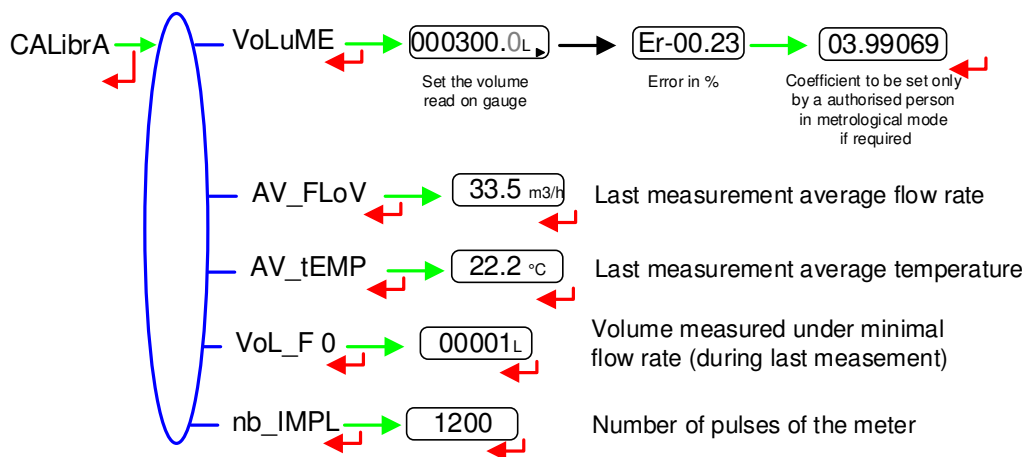

4.3.2 Sub-menu SEASON – SEASon

Season is set in METROLOGICAL mode. This menu is used to change from summer to winter time (and back again).

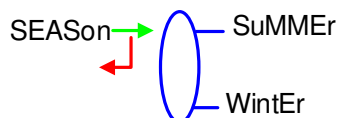

4.3.3 Sub-menu PARAMETERS – PARAMeT

This menu displays the parameters set in METROLOGICAL mode.

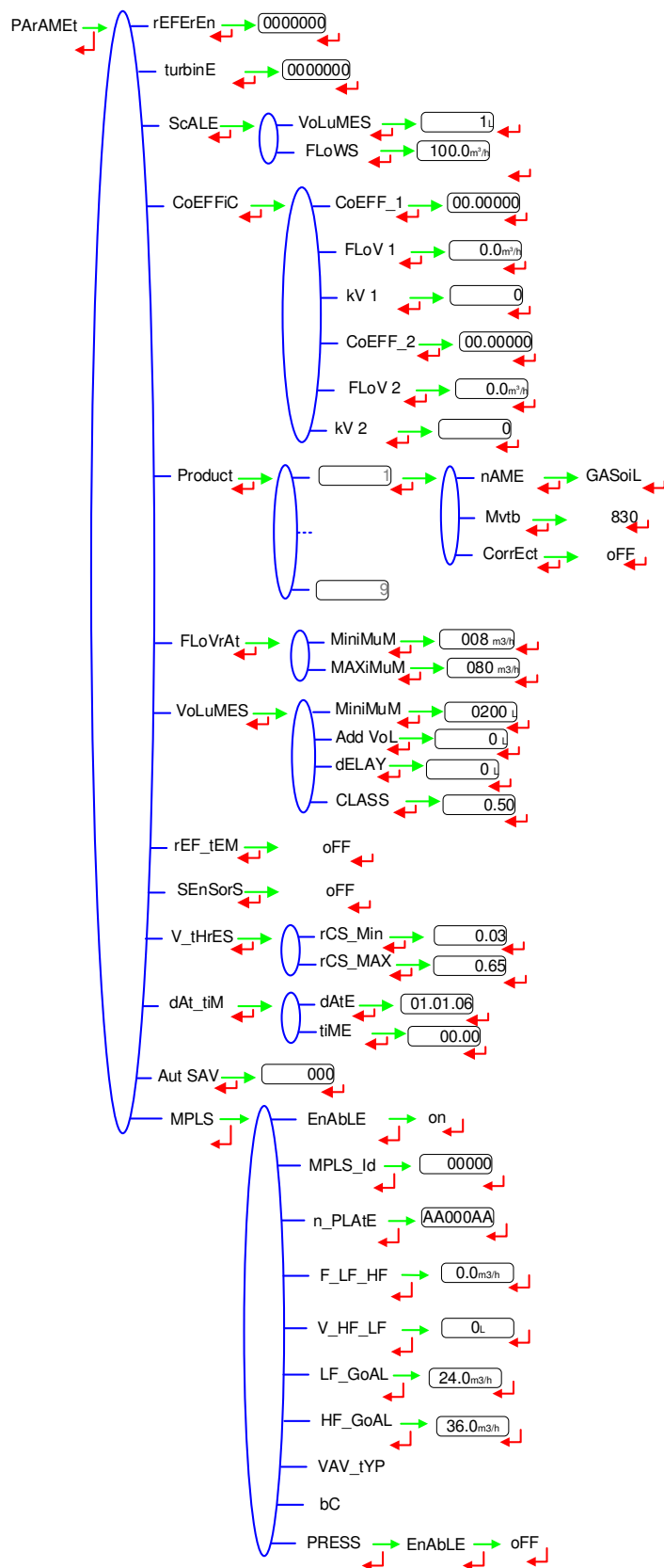

4.3.4 Sub-menu MAINTENANCE – MAIntEn

This menu displays the drain current (mA) of the gas detectors and the reference current set in METROLOGICAL mode.

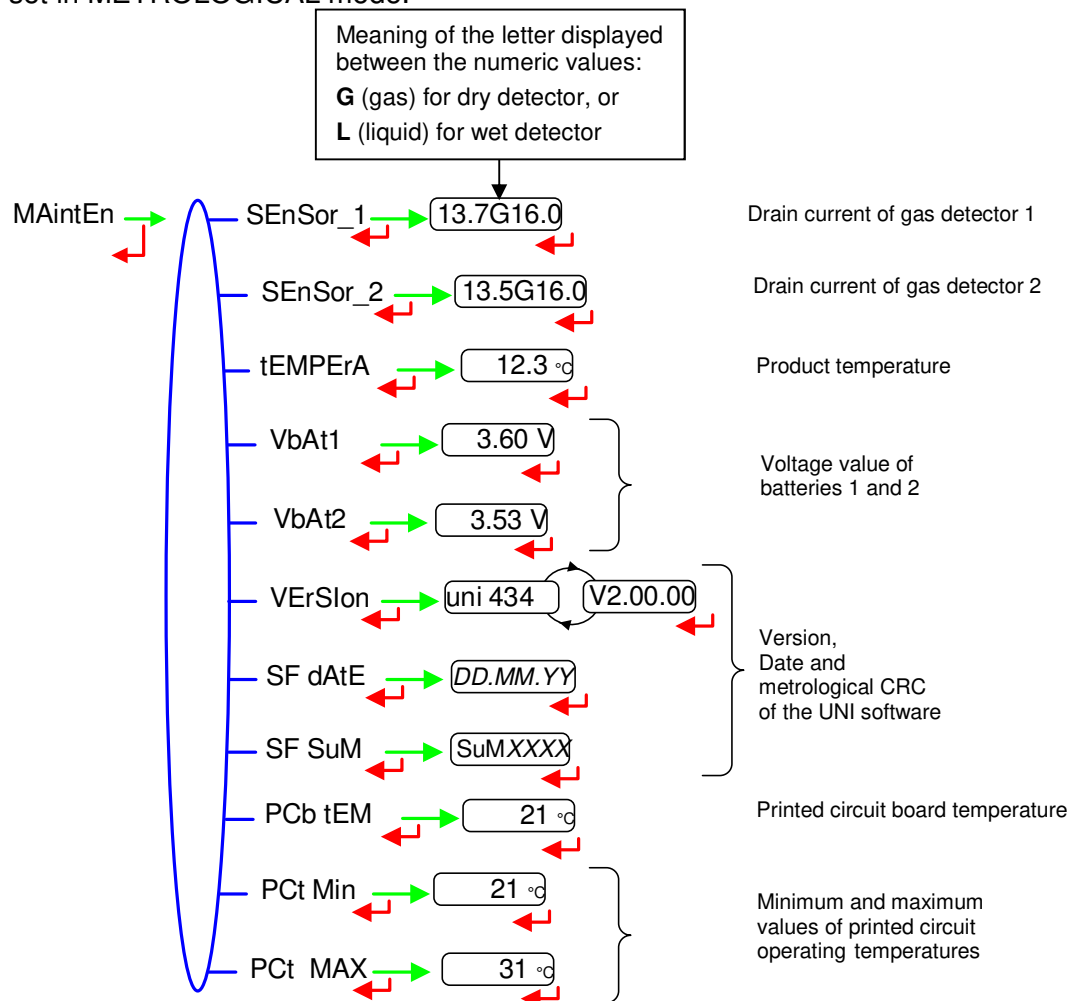

4.3.5 Sub-menu TRANSFERT – trAnSFr

Since the CTD+ key is not ATEX, this operation must be done outside potentially explosive area.

This sub-menu is available with the 'Transfer Key CTD+' option. It is used to transfer to the key the parameters set in METROLOGICAL mode and the measurement results and to download it to a PC. The file format is '.csv'. Refer to the Operating guide GU 71 10.

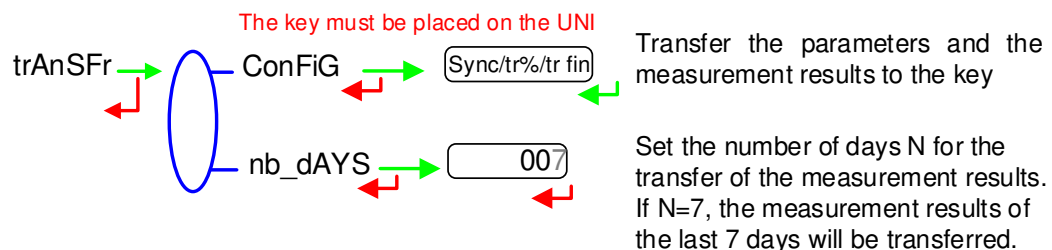

NOTE: Do not plug the USB cable during data transfer

4.4 List of alarms

Should a fault occur, the UNI displays the word "ALArM" and the fault title on the display (using some or all of the seven digits) followed by the displayed value. The operator acknowledges the fault by pressing down BP2 (even when pouring). Apart from battery related faults, persistent faults cannot be acknowledged. Once the fault is acknowledged, the selected value is displayed alternately with "-----" to indicate that the measured values are no longer guaranteed.

	DISPLAY	MEANING	ACTION
USER	oVErFLo	Volume greater than 4 194 304 liters	Reset the device
	LoW_FLo	Flow rate less than the setting minimal flow rate	Check the hydraulic configuration and the flowing
	SEnSor1	High gas detector fault (GDh)	Use the maintenance menu to check the status of the detector
	SEnSor2	Low gas detector fault (GDI)	Use the maintenance menu to check the status of the detector
REPARATOR	FLoV_	Flow setting fault	Check the parameters
	FrEQ_	Frequency fault	Check the parameters
	COEFF_	Difference between two coefficients is greater than 0,5%	Check the coefficients setup
	MEtEr	Problem of metering with the meter	Check the setup
	HiGH_FL	Flow rate greater than the setting maximal flowrate	Check the setup
	LF_HiGH	Flow greater than 20m ³ /h while GDh dry	Check the setup
	dAtE	Loss of date and time	Set date and time in metrological mode
	GAS	GDh is wet but GDI is dry	Check the hydraulic configuration / Check the detector status
	drY MEt	When using a pump. The volume of gas is greater than the minimum measured quantity	Stop metering
	CoIL	Loss of pulse transmitter signal	Check the connection with the pulse transmitter
	tEMPErA	Temperature less than -20°C or greater than 50°C	Check the temperature sensor (measure and calibration)
	dISPLAY	LCD display fault	If steady alarm, substitution of the UNI
	doG	Fault with card	If steady alarm, substitution of the UNI
	ProGrAM	Error on the checksum of the metrological data	If steady alarm, substitution of the UNI
	rAM	Saved memory fault	If steady alarm, substitution of the UNI
	MEMoriS	Bad writing into the memory	If steady alarm, substitution of the UNI
	FuLL	If a measurement result, not older than 3 months, is about to be erased	If steady alarm, substitution of the UNI
	MEtro_	Configuration loss	If steady alarm, substitution of the UNI
	bAttErY	Low battery	Substitution of the batteries
	totAL_	Totaliser fault	If steady alarm, substitution of the UNI
dEF_MEM	Loss of backup data concerning the last measurement	If steady alarm, substitution of the UNI	
dEF_CoM	Communication fault with IRDA link	Check the IRDA link	
rECEPt	Problem of communication protocol between the calculator-indicator UNI and the CTD+ key	Check the compatibility	

5 METROLOGICAL MODE

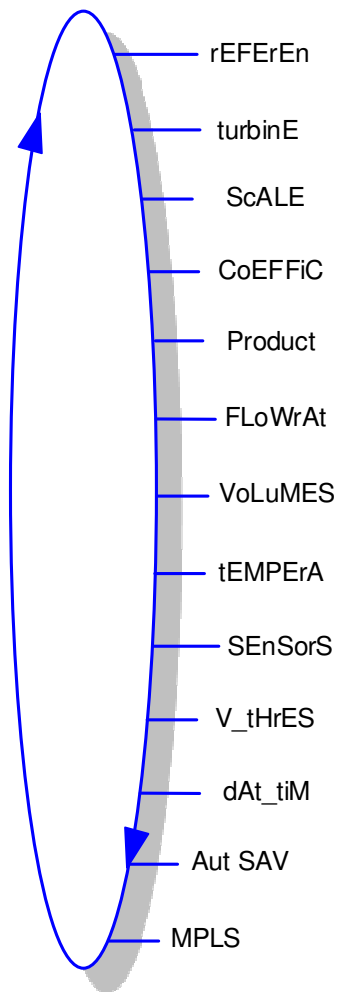

The configuration parameters can only be modified after the processor configuration switch on the electronic card has been switched over. Only authorized personnel can modify these parameters.

Exit the METROLOGICAL mode thanks to the switch; the device is then reset.

IMPORTANT

Setup should be done under cover, metering off, with dry gas detectors.

The option to display the volume in metering conditions (Vm) or the volume converted to base conditions (Vb) is made in METROLOGICAL mode when the temperature menu is activated.

5.1 Menu REFERENCE – rEFErEn

Set the serial number of the electronic calculator-indicator UNI.

rEFErEn → ←

5.2 Menu TURBINE – turbinE

Set the serial number of the turbine meter.

turbinE → ←

5.3 Menu SCALE – ScALE

Choose the unit and accuracy for volume and flowrate.

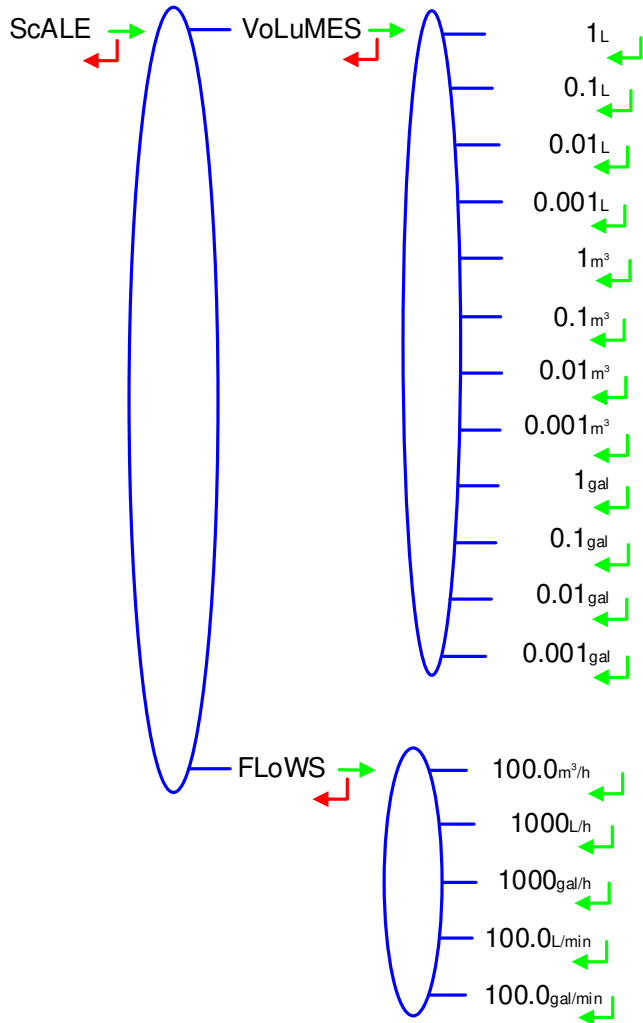

5.4 Menu COEFFICIENT – CoEFFiC

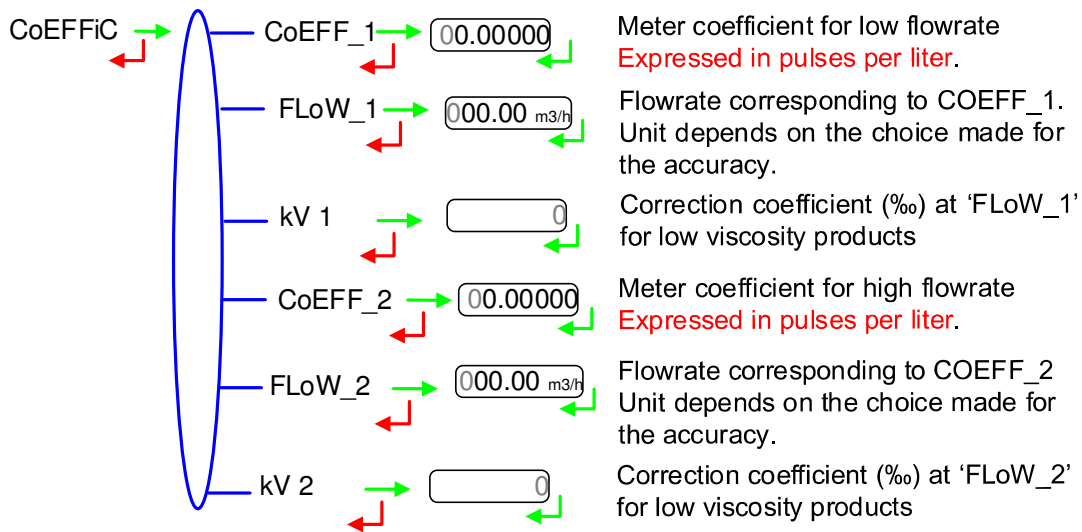

When parameters FLoW_1 and FLoW_2 are set to zero, parameters CoEFF_2 and kV 2 are not applied.

Adjustment of coefficients for several flowrates:

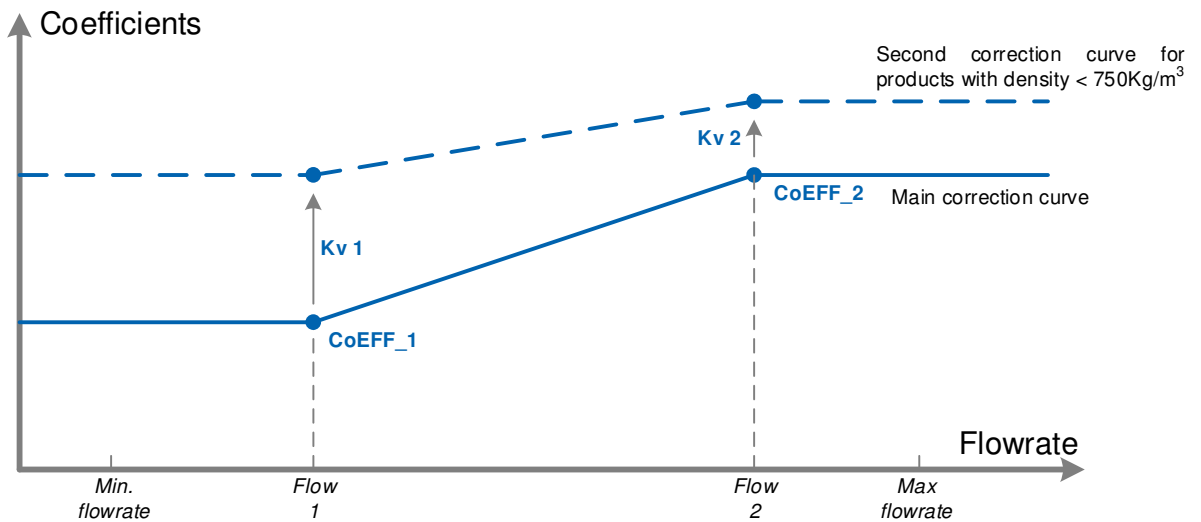

Coefficients applied in accordance with flowrate and product density

5.5 Menu PRODUCTS – Product

Definition of products.

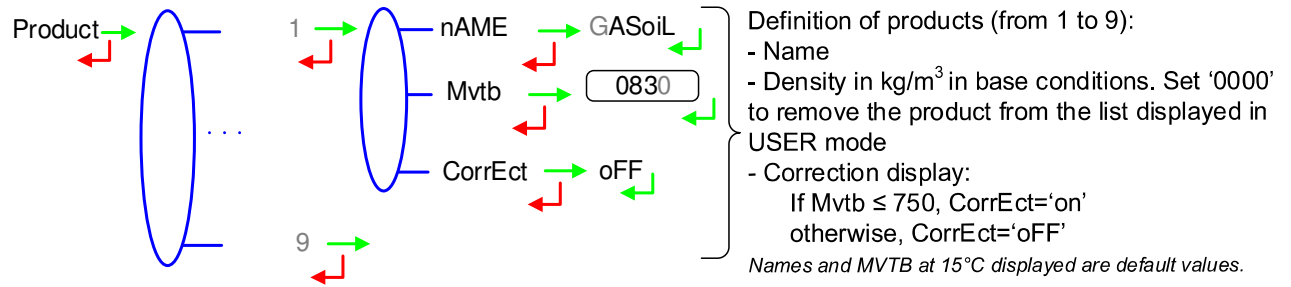

5.6 Menu FLOWRATES – FLoWrAt

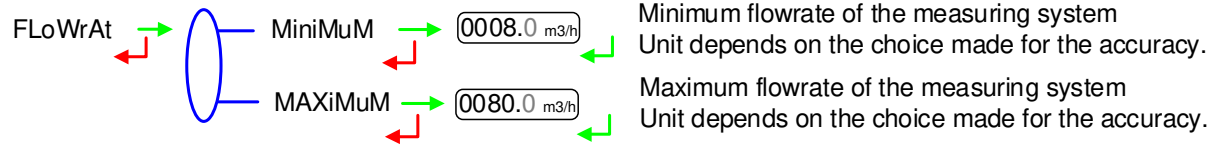

5.7 Menu VOLUMES – VoLuMES

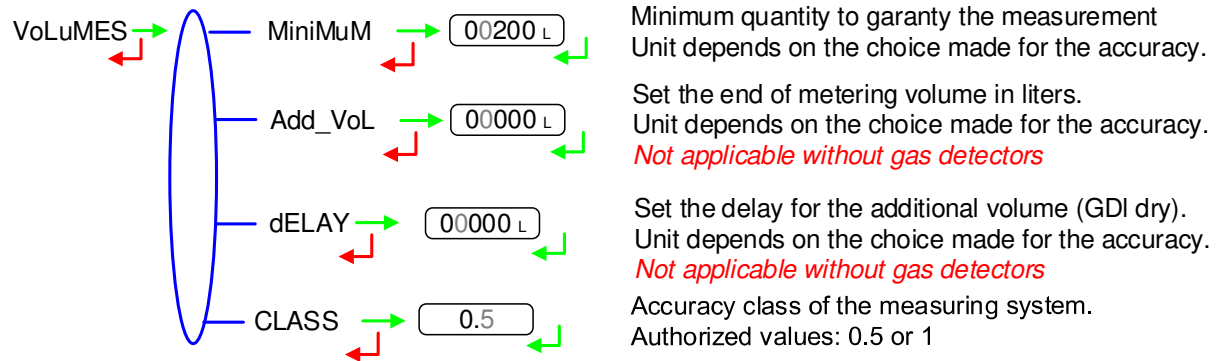

5.8 Menu TEMPERATURE – tEMPErA

The temperature calibration can be done either on two measuring points or on a single measuring point (menu CALibrA).

- Two temperature measuring points:
The measure must be done outside the range -20 to +50°C. Adjust the PT100 simulator to a value < -20°C, wait for 15 seconds before setting the temperature into the calculator. Then do the same for a value > +50°C.
- Single temperature measuring point:
The measure must be done in the range -20 to +50°C.

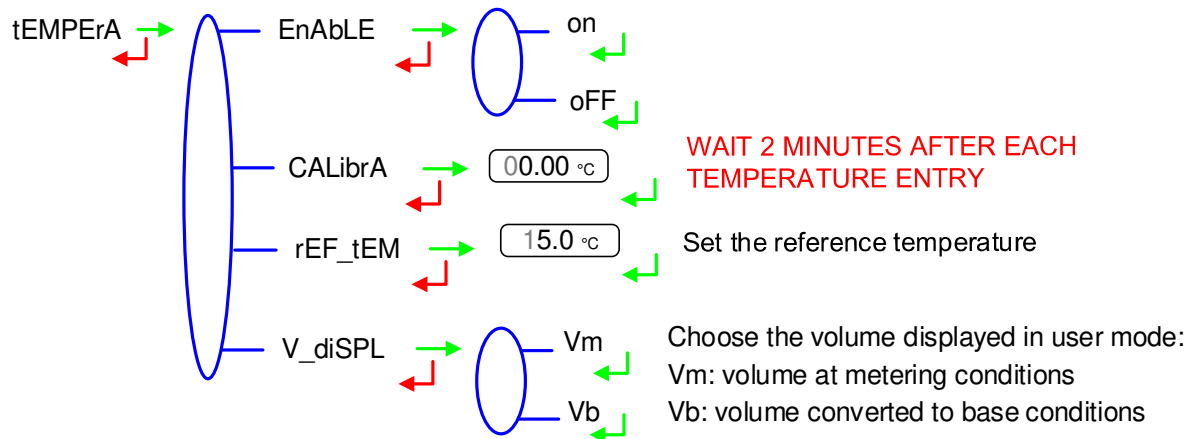

5.9 Menu GAS SENSORS – SEnSorS

The calculator-indicator UNI may be associated to 2 gas detectors.

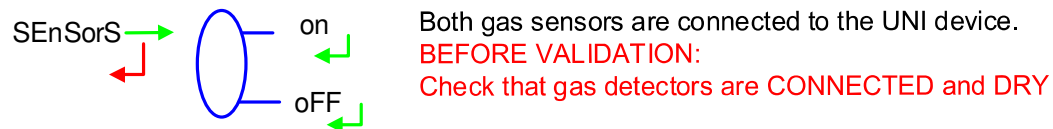

5.10 Menu THRESHOLDS – V tHrES

Detection thresholds of metering inputs at zero flow and at maximal flow.

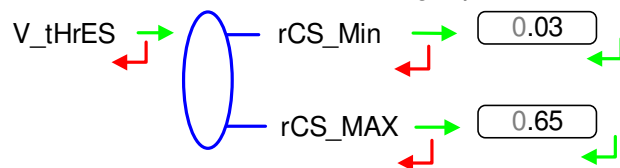

5.11 Menu DATE AND TIME – dAt tiM

This menu is used to set date and time of the day and select the season. The menu SuPErVi>SEASon of USER mode can also be used to change from summer to winter time (and back again).

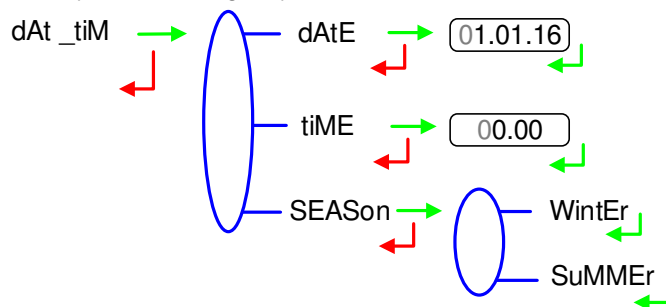

When you validate the season, 'dEL yES' then 'dEL Ok' appear to indicate that the measurement results have been deleted from flash memory.

5.12 Menu AUTOMATIC RECORDING – Aut SAV

Set the time required at the end of measurement before automatic recording of the measurement data (in seconds). A value other than zero disables the RAZ key. Manual reset is no more possible.

Set the value to '0' when the UNI calculator is associated to an MPLS device.



5.13 Menu MPLS – MPLS

This menu must be activated in the case of an interruptible measuring system; the UNI calculator is then associated to an MPLS device.

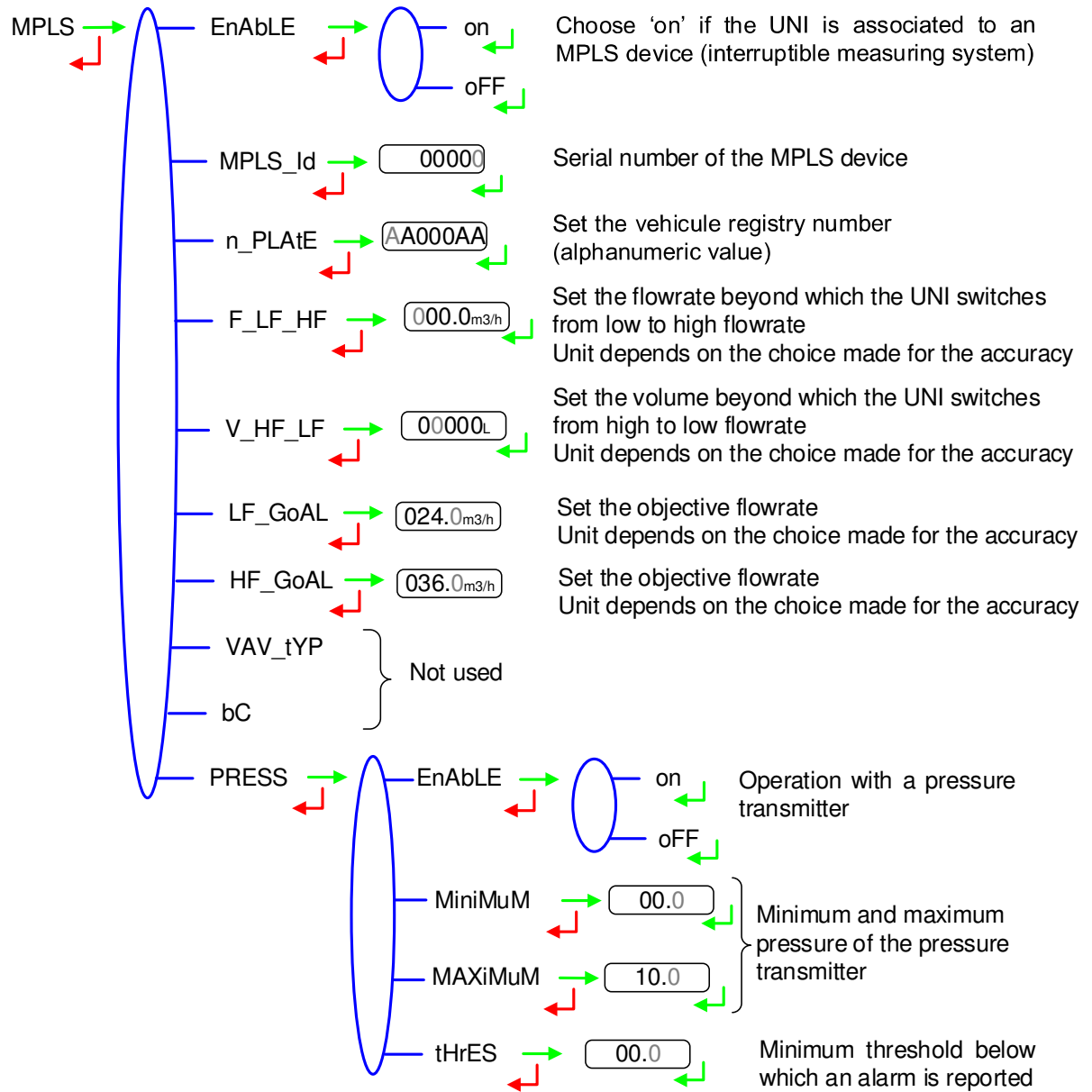

ANNEX

Delivery ticket for interruptible measuring systems connected to a printer

Installation:	AA09C01
Indicateur/Indicator:	0000000123
Date (../MM/20..):	21/10/2015
Quantieme/Calendar:	295
Numero/Number:	001
Heure de fin/ End time:	15:22
Produit/Product:	GAZoLE
Quantite livree/ Quantity delivered:	0000499 (L)
Totalisateur/Totaliser:	
Index avant/before:	0012387
Index apres/after:	0012886
<p>En cas de litige, les resultats de mesurage memorises par l'indicateur font foi. In case of dispute, the measurement results stored by the main indicating device providing proof.</p>	

RELATED DOCUMENTS

GU 7061	Operating guide: UNI
GU 7074	Operating guide: UNI MPLS
GU 7109	Operating guide: UNI dye-counter
GU 7110	Operating guide: Transfer the measurement results of the UNI indicator to a computer
FM 8009	Replacement of the batteries of the UNI indicator device
FM 8014	Replacement of the battery on the CTD+ key
FM 8505	Adjustment of an ALMA measuring system equipped with a UNI indicator device
FM 8509	Adjustment of temperature in the UNI indicator device