

**OPERATING MANUAL**

**MU 7070 EN A**  
**FLEXICOMPT+ D25 MONO OR DUAL**

---

A	2016/01/05	Creation	DSM	PJ
Issue	Date	Nature of modifications	Written by	Approved by

	MU 7070 EN A FLEXICOMPT+ D25 MONO OR DUAL	Page 1/23
	This document is available at <a href="http://www.alma-alma.fr">www.alma-alma.fr</a>	

# CONTENTS

<b>1</b>	<b>GENERAL PRESENTATION AND DESCRIPTION:</b>	<b>4</b>
<b>2</b>	<b>OPERATING RECOMMENDATIONS:</b>	<b>5</b>
<b>3</b>	<b>OPERATION MODES OF THE INDICATOR DEVICE:</b>	<b>5</b>
<b>4</b>	<b>DRIVER MODE:</b>	<b>6</b>
<b>4.1</b>	<b>Menu DELIVERY</b>	<b>6</b>
4.1.1	Delivery in free mode	7
4.1.2	Delivery in limitation mode	7
<b>4.2</b>	<b>Menu PRINTING</b>	<b>8</b>
<b>4.3</b>	<b>Menu DISPLAY</b>	<b>9</b>
4.3.1	Sub-menu TOTALISERS	9
4.3.2	Sub -menu LAST MEASUREMENT	9
4.3.3	Sub -menu MEMORIZATION	9
<b>4.4</b>	<b>Menu MAINTENANCE</b>	<b>10</b>
<b>4.5</b>	<b>List of alarms</b>	<b>11</b>
<b>5</b>	<b>SUPERVISOR MODE:</b>	<b>12</b>
<b>5.1</b>	<b>Menu CALIBRATION</b>	<b>12</b>
<b>5.2</b>	<b>Menu PRODUCTS</b>	<b>13</b>
<b>5.3</b>	<b>Menu VEHICLE</b>	<b>13</b>
<b>5.4</b>	<b>Menu SETTINGS – <i>Not applicable</i></b>	<b>13</b>
<b>5.5</b>	<b>Menu HOUR ADJUSTMENT</b>	<b>13</b>
<b>5.6</b>	<b>Menu LANGUAGE</b>	<b>13</b>
<b>5.7</b>	<b>Menu PARAMETERS</b>	<b>14</b>
5.7.1	Sub-menu CONFIGURATION	14
5.7.2	Sub-menu measuring system EMA	15
5.7.3	Sub-menu measuring system EMB	15
<b>6</b>	<b>METROLOGICAL MODE:</b>	<b>16</b>
<b>6.1</b>	<b>Menu INDICATOR REFERENCE</b>	<b>16</b>
<b>6.2</b>	<b>Menu CONFIGURATION</b>	<b>16</b>
6.2.1	Sub-menu TYPE	16
6.2.2	Sub -menu MODE	17
6.2.3	Sub -menu UNIT AND ACCURACY	17
<b>6.3</b>	<b>Menu measuring system EMA</b>	<b>17</b>
6.3.1	Sub-menu INDEX EM	17
6.3.2	Sub-menu METER REFERENCE	18
6.3.3	Sub-menu METER COEFFICIENT	18
6.3.4	Sub-menu CORRECTION	18

6.3.5	Sub-menu FIXED VOLUME – <i>Not applicable</i> .....	18
6.3.6	Sub-menu DELAY – <i>Not applicable</i> .....	18
6.3.7	Sub-menu DRAINING .....	18
6.3.8	Sub-menu TEMPERATURE .....	18
6.3.9	Sub-menu GAS DETECTOR .....	19
6.3.10	Sub-menu VALVE – <i>Not applicable</i> .....	19
6.3.11	Sub-menu VOLUME SETTINGS .....	19
6.3.12	Sub-menu FLOWRATE SETTINGS.....	19
<b>6.4</b>	<b>Menu measuring system EMB .....</b>	<b>19</b>
6.4.1	Sub-menu EMB (LEFT).....	19
6.4.2	Sub -menu EMB (NOT AVAILABLE) .....	20
<b>6.5</b>	<b>Menu DATE AND TIME .....</b>	<b>20</b>
<b>ANNEXE.....</b>		<b>21</b>
<b>RELATED DOCUMENTS .....</b>		<b>23</b>

## 1 GENERAL PRESENTATION AND DESCRIPTION:

The FLEXICOMPT+ MONO or DUAL is a multi-product measuring system intended for delivery of liquids other than water. It is designed for installation on road-tankers.

It is designed to measure, by gravity, volumes of liquid in limitation or free mode. The hydraulic flowmeter is associated to a single road-tanker.

The FLEXICOMPT+ D25 MONO is fitted with one MICROCOMPT+ device and one removable hydraulic flowmeter as part of the measuring system EMA. It controls one or several compartments.

The FLEXICOMPT+ D25 DUAL is fitted with one MICROCOMPT+ device and two removable hydraulic flowmeters forming two measuring systems EMA and EMB. It controls one or several compartments.

On the MICROCOMPT+ display screen, pictograms 'EMA' and 'EMB' are used to identify the measuring system in operation.

The FLEXICOMPT+ D25 is fitted with the following components:

- ⇒ One removable hydraulic flowmeter fitted with:
  - An API gravity coupler
  - An upstream flow-limiting sieve
  - An ALMA vacuity sensor upstream of the turbine meter
  - A DN80-80 ADRIANE turbine meter
  - A sight glass downstream of the turbine meter
  - A temperature probe (option)
  - A vacuum breaker
  - A DN80 coupling
- ⇒ A MICROCOMPT+ electronic calculator-indicator device
- ⇒ An hydraulic unloading device at the flowmeter outlet including one or several removable empty hoses

In option, the FLEXICOMPT+ D25 controls the product temperature. In addition, it may be connected to a printer for delivery tickets, totalisers, parameters, and summary or diary printings.

**NOTE:** Information printed on the printer has no metrological value. Only the values displayed by the main indicating device providing proof.

Presentation of the MICROCOMPT+ calculator-indicator:



	MU 7070 EN A FLEXICOMPT+ D25 MONO OR DUAL	Page 4/23
	This document is available at <a href="http://www.alma-alma.fr">www.alma-alma.fr</a>	

Buttons function:

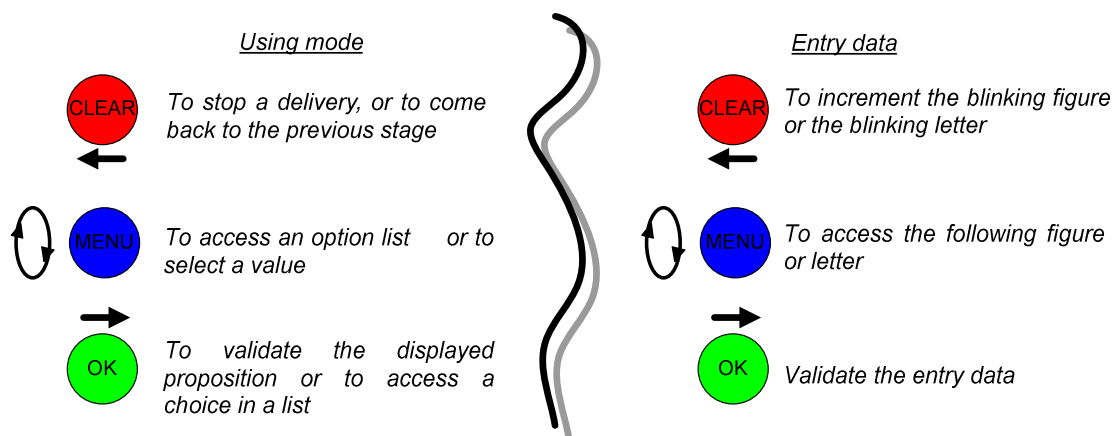

The MICROCOMPT+ calculator-indicator manages measuring operation and computerizes the measuring system defaults.

## 2 OPERATING RECOMMENDATIONS:

Before using a FLEXICOMPT+ D25 measuring system, the operator must ensure that the following conditions have been met:

- ⇒ The road-tanker must be equipped with API adapters
- ⇒ The road-tanker must be fitted with a location device of the reference position
- ⇒ The tank operating position does not differ by  $\pm 2\%$  from the horizontal reference position
- ⇒ During measurement, the hydraulic flowmeter is positioned on the API adapter of the compartment with a minimum angle of  $15^\circ$  to the horizontal. This condition is met if the coupler locking hooks are located closer to the horizontal position
- ⇒ The unloading hose(s) must be installed to ensure an easy outflow during delivery; the maximum length of the discharge DN80 hose, is 12 metres
- ⇒ The operator must remain beside the measuring system FLEXICOMPT+ D25 during delivery to stop the flow, if necessary, by closing the API valve of the road-tanker.

## 3 OPERATION MODES OF THE INDICATOR DEVICE:

### **Driver mode**

This is the normal using mode in exploitation.

Refer to DRIVER MODE

### **Supervisor mode**

To access the supervisor mode, the magnetic key must be put at the right of the MICROCOMPT display. This mode is used to set the measuring system and to access the calibration menu.

Refer to SUPERVISOR MODE for setup.

### **Metrological mode**

To access the METROLOGICAL mode, the MICROCOMPT has to be unsealed. Only an authorized person can remove the seal. This mode allows setting all metrological parameters. It's done at the putting into use of the measuring system and sometimes during metrological controls.

Refer to METROLOGICAL MODE for configuration.

	MU 7070 EN A FLEXICOMPT+ D25 MONO OR DUAL	Page 5/23
	This document is available at <a href="http://www.alma-alma.fr">www.alma-alma.fr</a>	

## 4 DRIVER MODE:

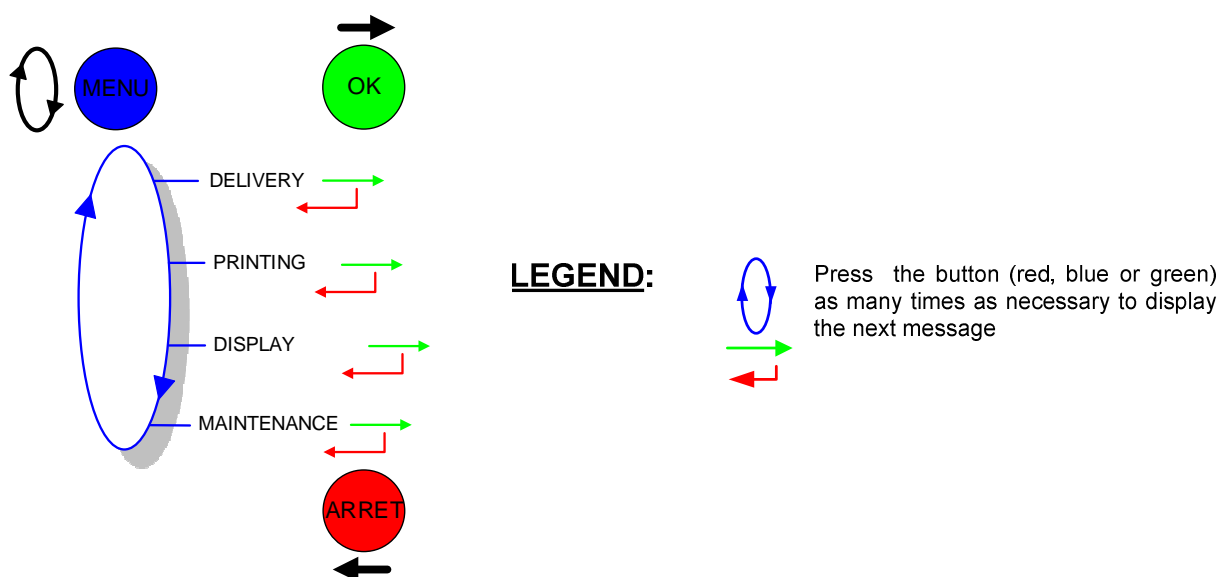

### 4.1 Menu DELIVERY

A delivery includes several operations. An operation includes the following stages:

- Validate Reset
- FLEXICOMPT+ D25 MONO: Validate the measuring system associated to the measurement  
FLEXICOMPT+ D25 DUAL: Choose the measuring system associated to the measurement
- Choose the compartment
- Choose the product
- Choose the distribution mode: limitation or free mode

At the end of an operation, press **MENU** to start a new operation.

At the end of the delivery, choose the menu END DELIVERY? Validate with **OK**.

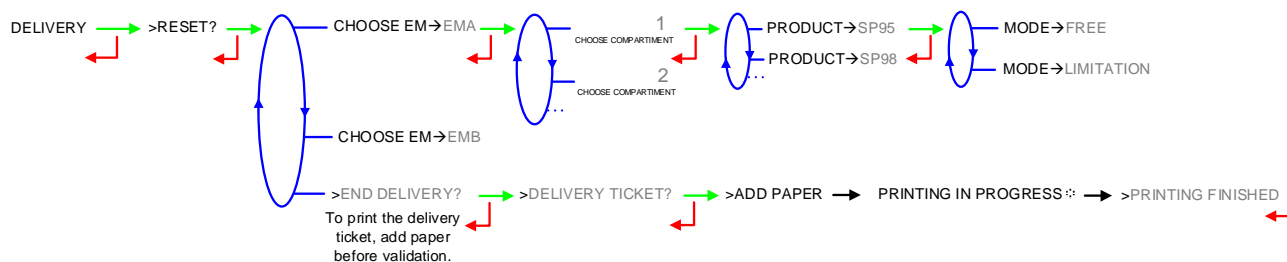

If the measuring system FLEXICOMPT+ D25 is MONO, the menu **CHOOSE EM->EMB** is not available.

During an operation, the following information may be displayed by pressing **MENU**:

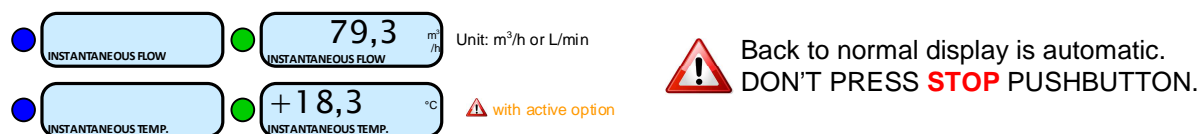

### 4.1.1 Delivery in free mode

Validate the distribution mode **MODE→FREE**.

Press **OK** to start the unloading cycle. End the unloading by pressing **STOP**



### 4.1.2 Delivery in limitation mode

Validate the distribution mode **MODE→LIMITATION** and set the volume. If the value is lower than the minimum volume, the measurement will be invalidated. The volume will be displayed alternately with dashes ‘-- -- --’

Press **OK** to start the unloading cycle.



## 4.2 Menu PRINTING

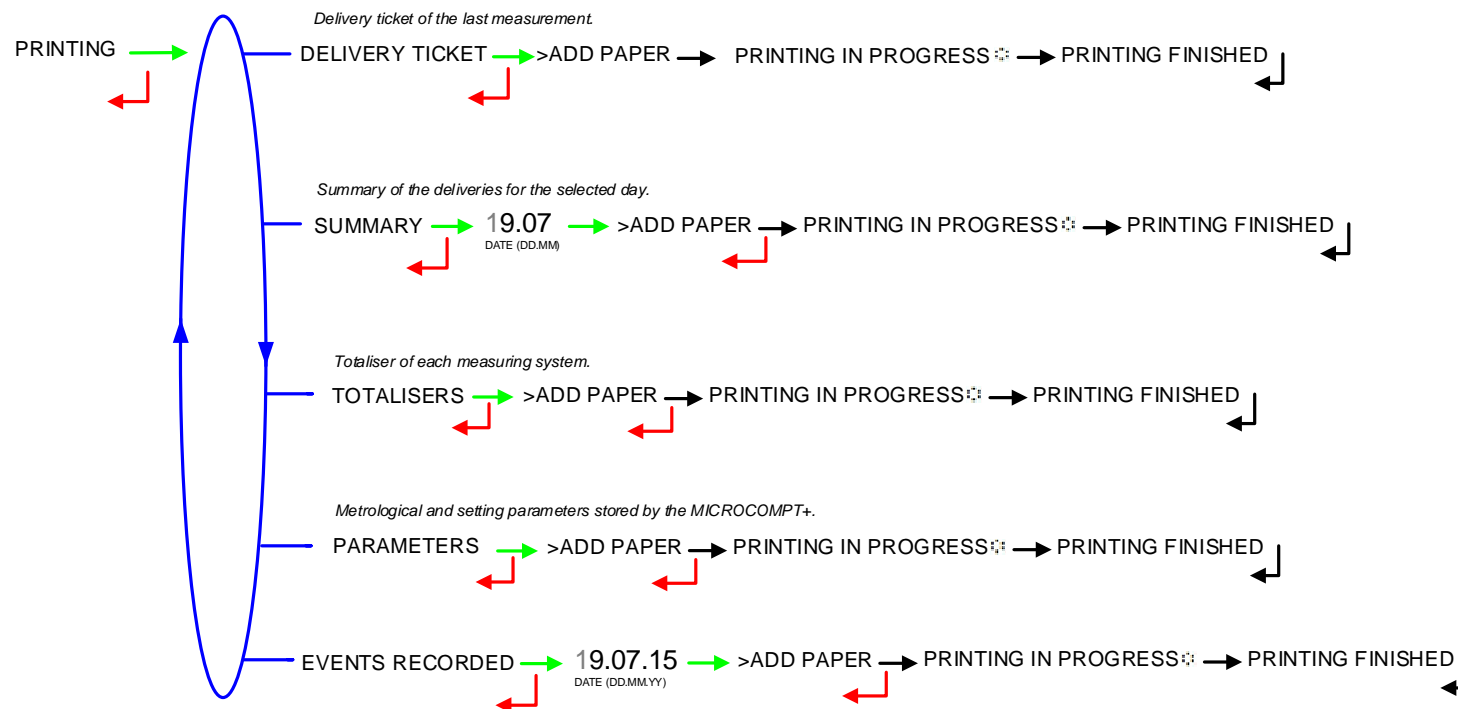



### 4.3 Menu DISPLAY

#### 4.3.1 Sub-menu TOTALISERS

Visualization of the totaliser of each measuring system. EMB is not available when the FLEXICOMPT+ D25 is MONO.

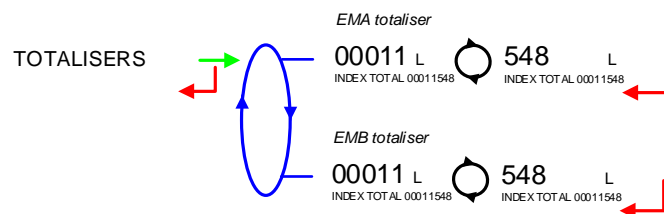

#### 4.3.2 Sub -menu LAST MEASUREMENT

The volume of the last measurement is displayed.

2044 L  
LAST MEASUREMENT

#### 4.3.3 Sub -menu MEMORIZATION

This menu is available in stand-by mode or during an intermediate stop. It allows the proofreading of all the measurement results stored by the FLEXICOMPT+ D25. That can be done in two ways:

**COMPLETE LIST:** Display all the measurement details recorded, from the newest to the oldest, sorted by day then by measurement number.

**DAY SELECTION:** Display a specific measurement by selecting the day number

For each measurement, are displayed: the number of the compartment assigned to the measuring system, the measured volume and the mean temperature of the product (with active option).

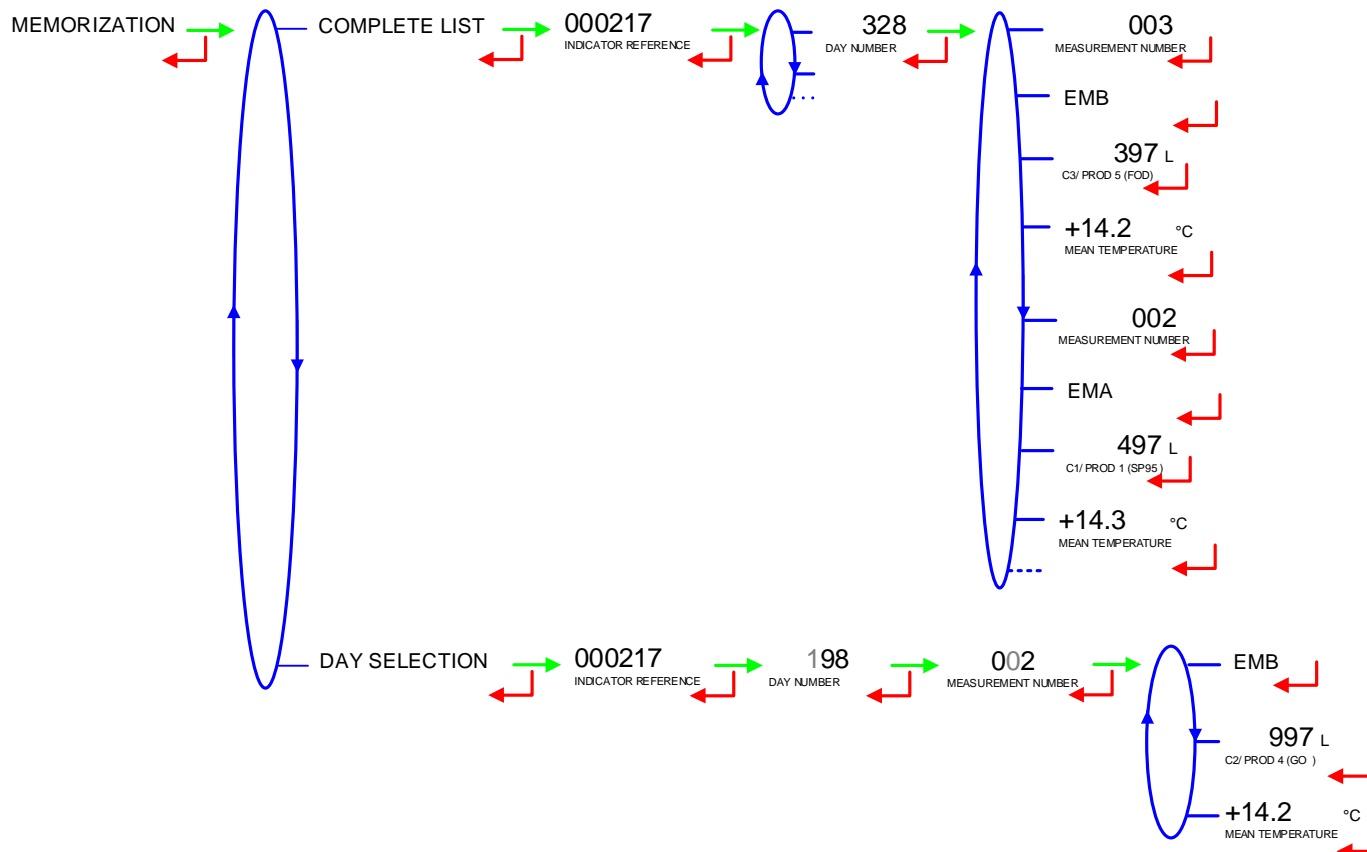

**4.4 Menu MAINTENANCE**

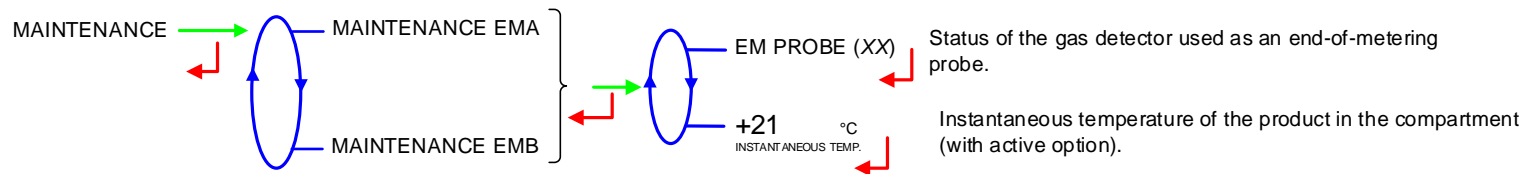

#### 4.5 List of alarms

Apparition of a default makes the pouring stop by closing the transfer valve. At the same time, the MICROCOMPT+ displays the associated alarm message. The operator must deal with the default and then validate the alarm.

		DISPLAY	MEANING	ACTION
USER		STOP OPERATION	Intentional interruption of discharge	Continue, stop or finish the operation
		PRINTER FAULT	No more communication with the printer	Check the connection cable, on-off switch and fuse
		POWER SUPPLY PROBLEM	Power outage during operation	Check the cause / Restore power supply
		ZERO FLOW FAULT	Zero flow	Check if the pulse transmitter is powered (red indicators)
		LOW FLOW FAULT	Low flowrate (less than 4m <sup>3</sup> /h)	Check the hydraulic system (valve, strainer, nozzle...)
		HIGH FLOW FAULT	High flowrate (greater than maximum flowrate)	Check the parameters / Reduce flowrate
		METERING PROBLEM	Metering problem with the measuring device	Check if the pulse transmitter is powered (red indicators)
	DIARY DEFAULT	Reset of the events diary	Acknowledge the alarm, check the date in supervisor mode (supervisor key)	
REPARATOR	NON BLOCKING	WATCHDOG FAULT	Fault with display or power card or AFSEC+ card	Switch on-off the MICROCOMPT+ / If steady alarm, substitution of the faulty card
		DISPLAY FAULT	Problem with display card	If steady alarm, substitution of the display card
		TOTALISER LOST	Loss of totaliser	Substitution of the backup battery
		SMP FAULT	End of metering probe out of order	If steady alarm, see a reparator for trouble shooting
		PROBE CALIB. FAULT	Problem with the calibration of one of the gas detectors	If steady alarm, see a reparator for trouble shooting
	TEMPERATURE FAULT	Temperature determination failure	Check the temperature probe status / If steady alarm, see a reparator for trouble shooting	
	BLOCKING	MEMORY LOST (PILE)	Loss of saved memory	Substitution of the backup battery
		MEMORY LOST	Delivery diary lost	Enter and exit the METRO mode / If steady alarm, substitution of the backup battery
		DATE AND TIME LOST	Loss of date and time	Set date and time in supervisor mode (supervisor key)
		GAS DETECTED	Air detection in high flowrate	If steady alarm, see a reparator for trouble shooting
		PROM DEFAULT	Loss of software or resident integrity	Substitution of the AFSEC+ electronic card
		RAM DEFAULT	Saved memory fault	Substitution of the AFSEC+ electronic card
		EEPROM MEMORY LOST	Loss of metrological configuration	Substitution of the AFSEC+ electronic card
		MEMORY OVER LOADED	Delivery diary is full	Substitution of the AFSEC+ electronic card

## 5 SUPERVISOR MODE:

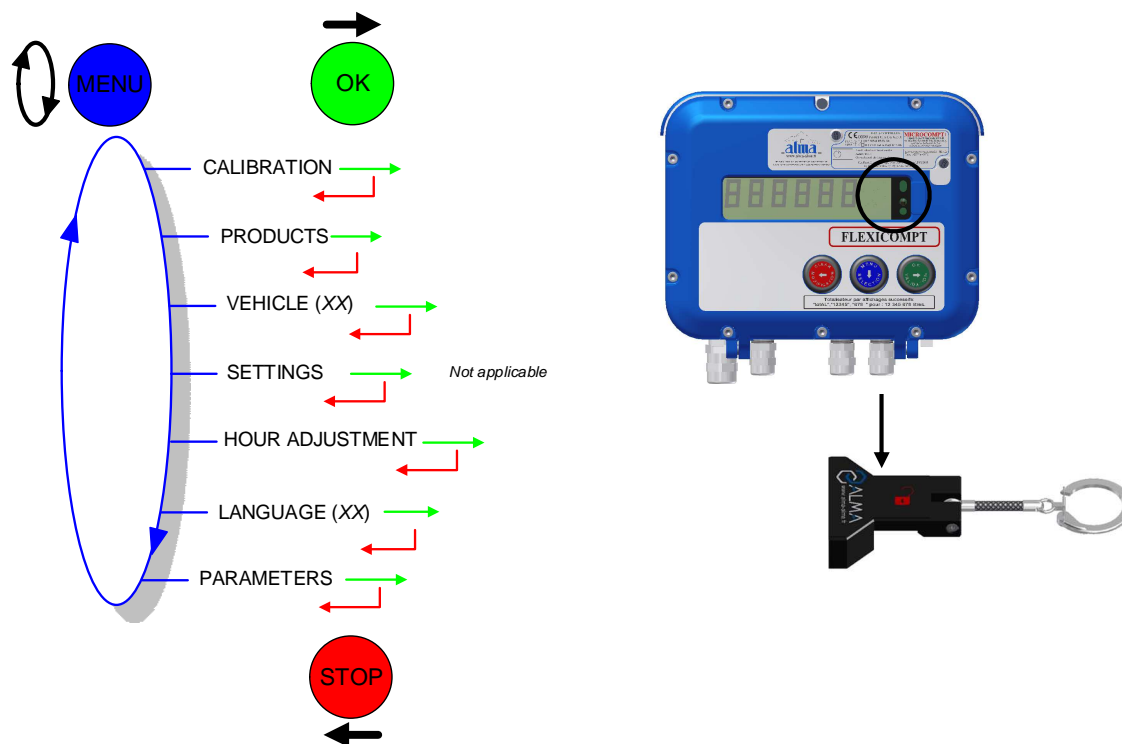

### 5.1 Menu CALIBRATION



This menu allows you to check the accuracy of the measuring system by calculating the measuring device error and the new corrected coefficient to be close to '0' error.

First, fill the gauge (DRIVER mode) with predetermination of the volume. Switch to SUPERVISOR mode, choose 'CALIBRATION' menu and validate. Enter the volume read on the gauge (reference volume) and validate. The MICROCOMPT+ calculates and displays the following information:

- The signed error in % between the counted volume and the volume read on the gauge
- The coefficient revised as a function of the error
- The average flow of the delivery.

These values are displayed one after the other by pressing the **GREEN** pushbutton.

### 5.2 Menu PRODUCTS

Definition of products. For the 5 first products, default names are proposed. To remove a product, enter blank space as name product. Maximum number of characters: 5.

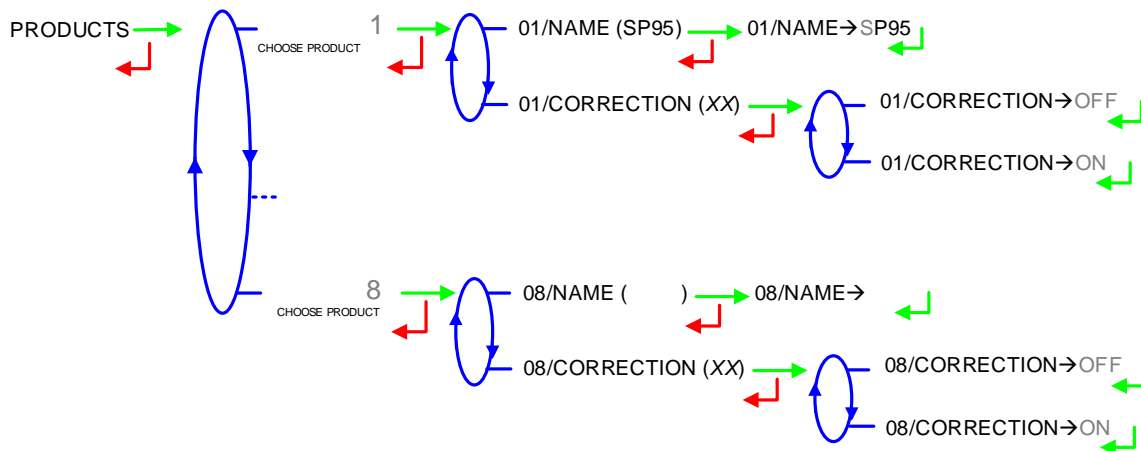

### 5.3 Menu VEHICLE

Set the vehicle registry number on which the FLEXICOMPT+ D25 is installed. This number will be printed on delivery tickets...



### 5.4 Menu SETTINGS – Not applicable

### 5.5 Menu HOUR ADJUSTMENT

Date and time are set in METROLOGICAL mode. The hour may be adjusted (±2h) one time a day through this menu.



### 5.6 Menu LANGUAGE

This menu is available if a translation catalogue has been uploaded in the MICROCOMPT+.

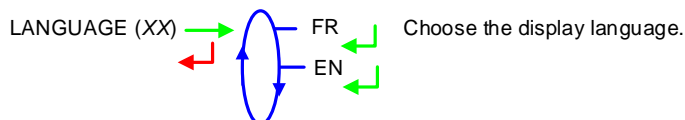

### 5.7 Menu **PARAMETERS**

This menu allows you to visualize the metrological parameters of the measuring system(s) set in METROLOGICAL mode.

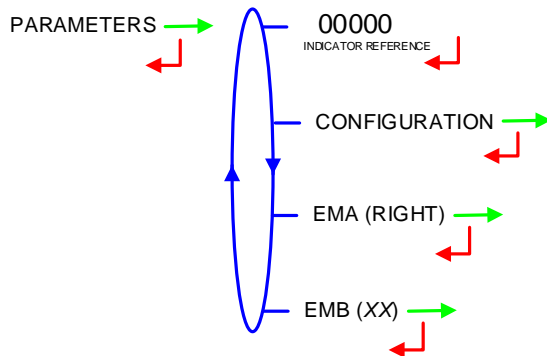

#### 5.7.1 Sub-menu **CONFIGURATION**

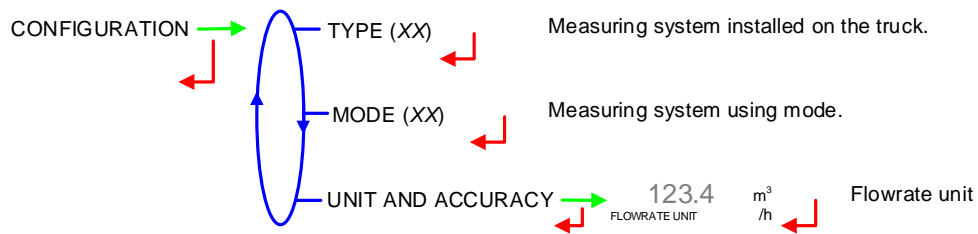

### 5.7.2 Sub-menu measuring system EMA

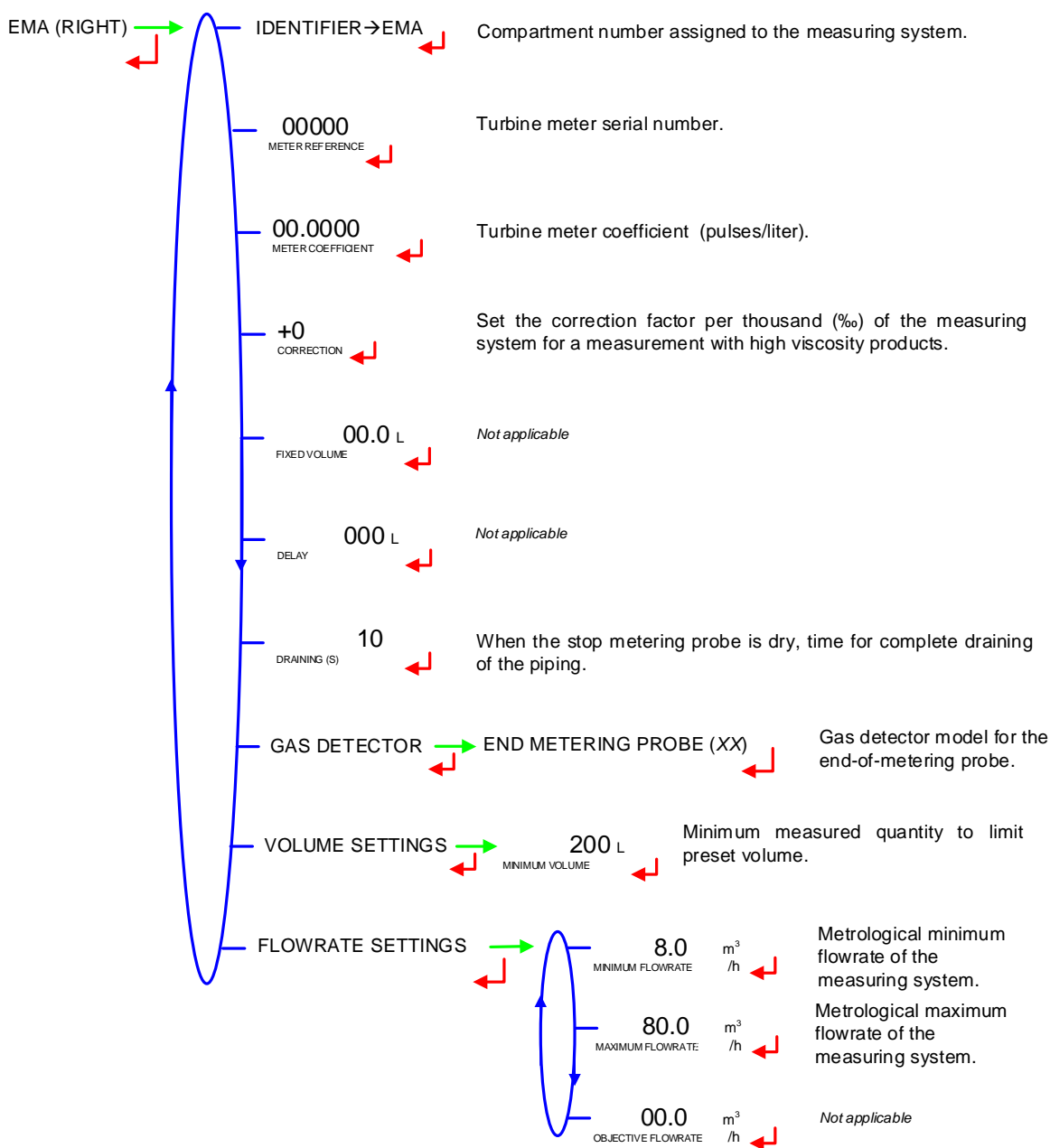

### 5.7.3 Sub-menu measuring system EMB

In DUAL using mode: display of the EMB measuring system parameters (idem EMA).  
 In MONO using mode, the EMB measuring system is not available.

## 6 METROLOGICAL MODE:

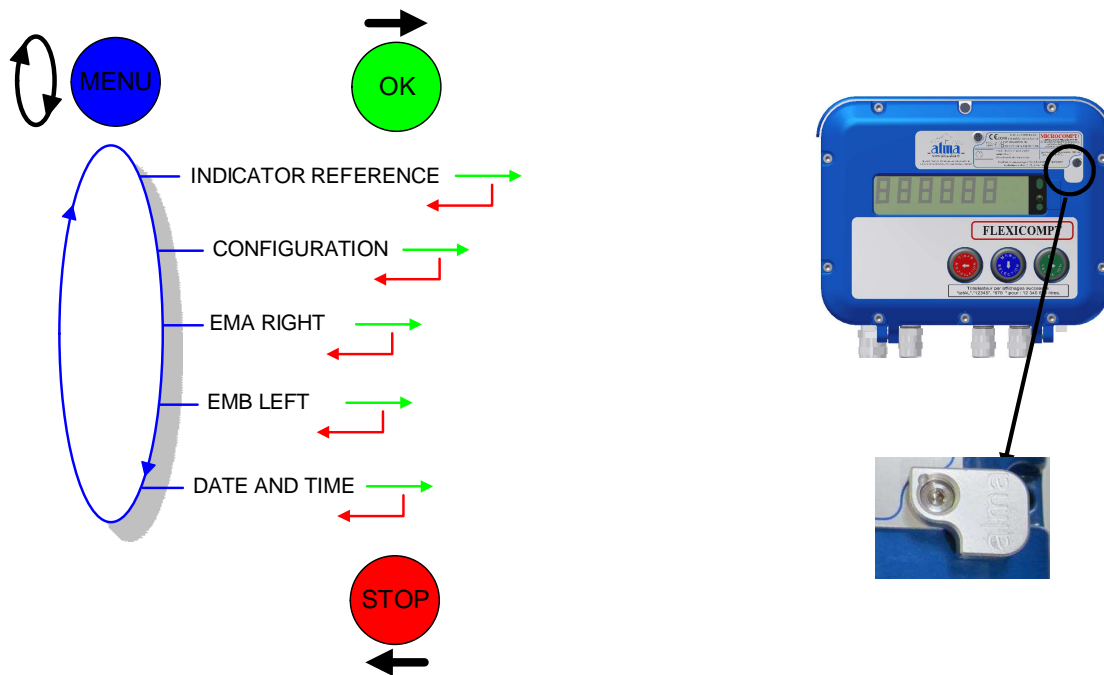

### 6.1 Menu INDICATOR REFERENCE

This menu is used to set a 5-figures numeric value to indicate the serial number of the FLEXICOMPT+ D25 indicator device.



### 6.2 Menu CONFIGURATION

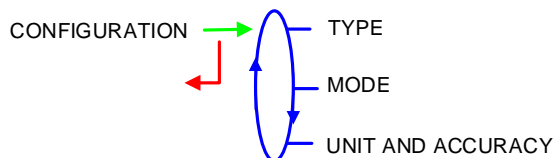

#### 6.2.1 Sub-menu TYPE

Ce menu permet de déterminer le type d'ensemble de mesure installé sur le camion. Valider le choix : **TYPE**→**FLEXICOMPT** et saisir le nombre de compartiments.

Set the model of the measuring system installed on the truck: choose FLEXICOMPT and set

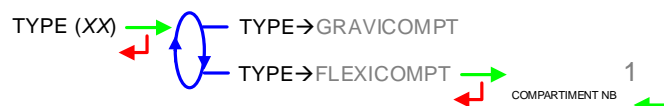

	MU 7070 EN A FLEXICOMPT+ D25 MONO OR DUAL	Page 16/23
	This document is available at <a href="http://www.alma-alma.fr">www.alma-alma.fr</a>	



### 6.2.2 Sub-menu MODE

Choose the using mode:

**MONO:** When the MICROCOMPT+ controls one measuring system.

**DUAL:** When the MICROCOMPT+ controls two measuring systems.

In DUAL mode, measuring systems can be controlled in two different ways:

**ALTERNATE:** Both measuring systems are controlled alternatively,

**SIMULTANEOUS:** Both measuring systems are controlled simultaneously.

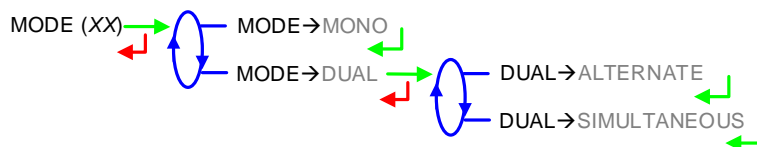

### 6.2.3 Sub -menu UNIT AND ACCURACY

Choose the flow rate unit which is displayed and printed.

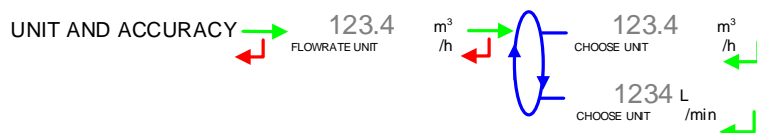

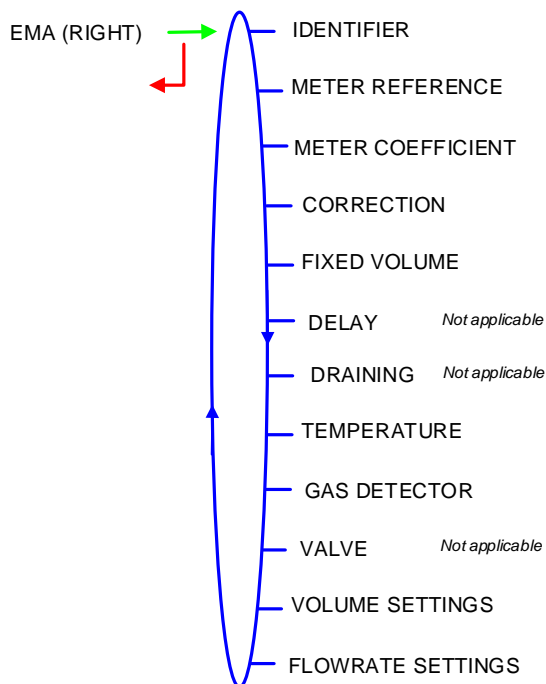

## 6.3 Menu measuring system EMA



### 6.3.1 Sub-menu INDEX EM

Set the compartment number assigned to the EMA measuring system.

	MU 7070 EN A FLEXICOMPT+ D25 MONO OR DUAL	Page 17/23
	This document is available at <a href="http://www.alma-alma.fr">www.alma-alma.fr</a>	

IDENTIFIER→EMA  

### 6.3.2 Sub-menu METER REFERENCE

Set the turbine meter serial number.

00000 → 00000  
 METER REFERENCE → METER REFERENCE  

### 6.3.3 Sub-menu METER COEFFICIENT

Set the coefficient of the measuring system meter (pulses/liter). To be calculated during calibration. Refer to MV 5008

0.0000 → 00.0000  
 METER COEFFICIENT → ENTER COEFFICIENT  

### 6.3.4 Sub-menu CORRECTION

Set the correction factor per thousand (‰) of the measuring system for a measurement with high viscosity products. See turbine markings or refer to ALMA calibration certificate.

+0 → +0  
 CORRECTION → ENTER CORRECTION  

### 6.3.5 Sub-menu FIXED VOLUME – *Not applicable*

### 6.3.6 Sub-menu DELAY – *Not applicable*

### 6.3.7 Sub-menu DRAINING

Set the time, in seconds, for complete draining of the piping once the end-of-metering probe is dry. Maximum value: 199. Enter zero to disable the function

30 → 030  
 DRAINING (S) → DRAINING (S)  

### 6.3.8 Sub-menu TEMPERATURE

This menu is an option. It is used to calibrate the temperature into the MICROCOMPT+. Refer to FM 8510

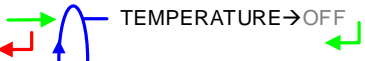
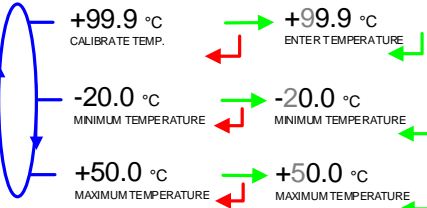
TEMPERATURE (XX) → TEMPERATURE→OFF  
  
 TEMPERATURE→ON → +99.9 °C → +99.9 °C  
 MINIMUM TEMPERATURE → MINIMUM TEMPERATURE  
 MAXIMUM TEMPERATURE → MAXIMUM TEMPERATURE  

### 6.3.9 Sub-menu GAS DETECTOR

**END METERING PROBE:** The end-of-metering probe must be an ATEX gas detector model. Then choose **EM PROBE→3001**. Make sure the sensor is dry before validating its status.

**LOW FLOW PROBE:** Not applicable

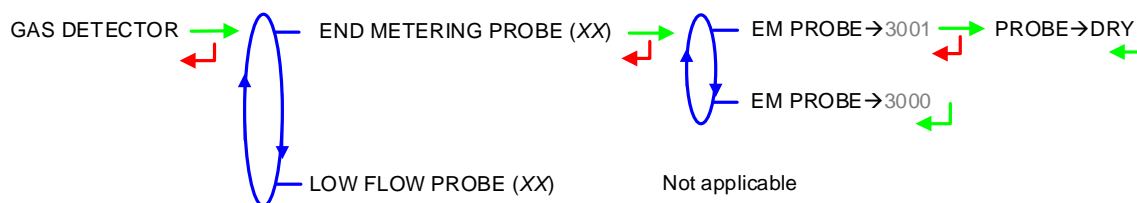

### 6.3.10 Sub-menu VALVE – Not applicable

### 6.3.11 Sub-menu VOLUME SETTINGS

**MINIMUM VOLUME:** Minimum measured quantity of the measuring system to limit volume (refer to the requirement of the EC-type examination certificate or to local requirements).



### 6.3.12 Sub-menu FLOWRATE SETTINGS

**MINIMUM FLOWRATE:** Metrological minimum flowrate of the measuring system in m<sup>3</sup>/h.

**MAXIMUM FLOWRATE:** Metrological maximum flowrate of the measuring system in m<sup>3</sup>/h.

**OBJECTIVE FLOWRATE:** Not applicable.

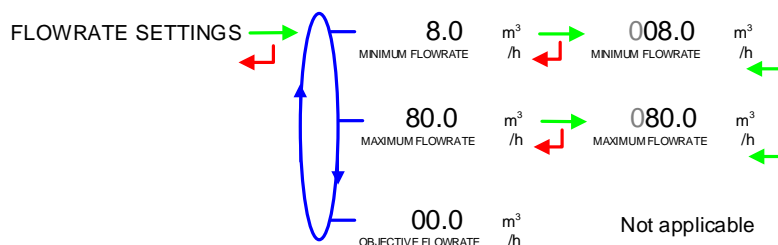

## 6.4 Menu measuring system EMB

When the FLEXICOMPT+ D25 is DUAL, the second measuring system is named EMB. The menu is **EMB (LEFT)**.

When the FLEXICOMPT+ D25 is MONO, the menu is **EMB (NOT AVAILABLE)**.

### 6.4.1 Sub-menu EMB (LEFT)

This menu allows you to set the configuration parameters of the second measuring system. Refer to 'MENU EMA (RIGHT)' for details.

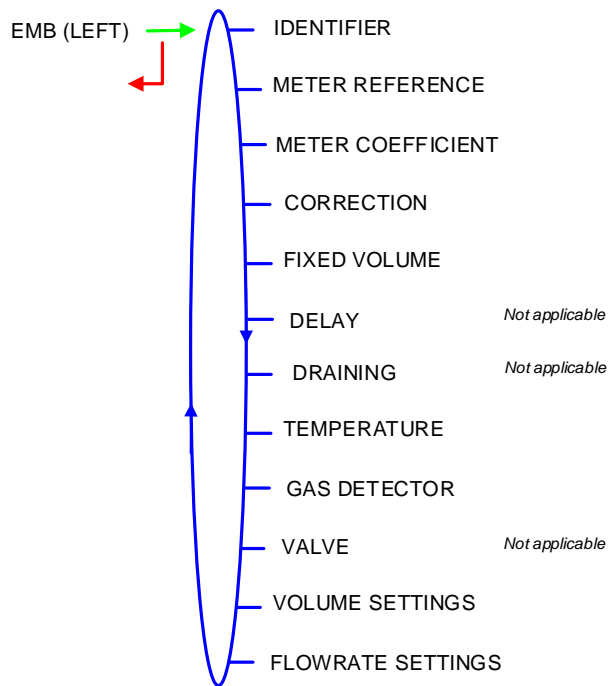

**6.4.2 Sub -menu EMB (NOT AVAILABLE)**

When the FLEXICOMPT+ D25 is MONO, EMB is not available.

**6.5 Menu DATE AND TIME**



**ANNEXE**

**SUMMARY:**

Printing of the measurements results

FLEXICOMPT 387+.001 carte v1r8  
 Version 03.01.01 du 01/04/15  
 Printed on the 17/11/15 at 17h20  
 Vehicle : AA-000-AA  
 Indicator : 03000

Summary  
 of measurements: 13/01/15  
 Day 009 004 memorised results

\*\*\*\* DAILY TOTALISERS \*\*\*\*

SP95	(1) :	00000696 L
SP98	(2) :	00000000 L
E-10	(3) :	00000000 L
GO	(4) :	00003136 L
Fod	(5) :	00000000 L
	(6) :	00000000 L
	(7) :	00000000 L
	(8) :	00000000 L

Total from 1 to 8 : 0003832 L

\*\*\*\*\* SUMMARY \*\*\*\*\*

No	Ident	Cpt	Product	Volume
001	EMA	1	(4)GO	03136 L
002	EMB	2	(1)SP95	*00696 L

In case of dispute, the measurement results stored by the main indicating device providing proof

\* : Delivery is invalidated.

**PARAMETERS:**

Printing of the indicator parameters

FLEXICOMPT 387+.001 carte v1r8  
 Version 03.01.01 du 01/04/15  
 Printed on the 17/11/15 at 17h20  
 Vehicle : AA-000-AA  
 Indicator : 03000

\*\*\*\*\* PARAMETERS \*\*\*\*\*

FLEXICOMPT 2 compartments  
 Alternate DUAL

Measuring system EM 1:

Identifier	:	EMA
Sleeve number	:	00319
Coefficient (p/l)	:	2.5000
Correction coef.	:	+0 Per thousand
Added volume	:	0.0 L
Delay	:	100 L } Non applicable
Pipe draining	:	:30.00 s
End metering probe	:	:3001
Valve	:	:two flow Non applicable

Measuring system EM 2:

Identifier	:	EMB
Sleeve number	:	00208
Coefficient (p/l)	:	2.5000 Per thousand
Correction coef.	:	+0
Added volume	:	0.0 L
Delay	:	100 L } Non applicable
Pipe draining	:	:30.00 s
End metering probe	:	:3001
Valve	:	:two flow Non applicable

Product	Name	Correct.
Pro 1	SP95	ON
Pro 2	SP98	ON
Pro 3	E-10	ON
Pro 4	GO	OFF
Pro 5	FOD	OFF
Pro 6		OFF
Pro 7		OFF
Pro 8		OFF

Volumes:

Low to high flow	:	0 L
High to low flow	:	0 L
Minimum quantity	:	200 L

Flowrates:

Minimum	:	8 m3/h
Maximum	:	80 m3/h
Objective flow	:	24 m3/h Non applicable

Timing:

Opening increment	:	:0.070 s
Relaxation in opening	:	:0.100 s
Closing increment	:	:0.020 s
Relaxation in closing	:	:0.200 s
ANTI-VORTEX stop	:	: 5.00 s

Last measurements:

Stop timing	EMA:	0.13 s
Stop flowrate	EMA:	0.01 m3/h
Stop volume	EMA:	0.20 L
Stop timing	EMB:	0.18 s
Stop flowrate	EMB:	0.01 m3/h
Stop volume	EMB:	1.00 L

**TOTALISER:**

Printing of the totaliser(s)

FLEXICOMPT 387+.001 carte v1r8  
Version 03.01.01 du 01/04/15  
Printed on the 17/11/15 at 17h20  
Vehicle : AA-000-AA  
Indicator : 03000

\*\*\*\*\* TOTALISERS \*\*\*\*\*

General totaliser EM1 (EMA):  
6928 litres

General totaliser EM2 (EMB):  
988 litres

In case of dispute, the measurement  
results stored by the main  
indicating device provding proof

**EVENTS RECORDED:**

Printing of the recordings

FLEXICOMPT 387+.001 carte v1r8  
Version 03.01.01 du 01/04/15  
Printed on the 17/11/15 at 15h20  
Vehicle : AA-000-AA  
Indicator : 03000

87 recording(s)

14:49:53 EMB – STOP OPERATION  
14:30:03 EMB – TEMPERATURE FAULT  
14:24:33 Driver mode  
14:24:26 Switch on  
...

09:47:15 Param @ 3= 5  
09:47:06 Param @ 2= 1  
09:42:57 Metrological mode  
08:59:02 Switch on  
08:58:57 Reset application

**DELIVERY TICKET:**

FLEXICOMPT 387+.001 carte v1r8  
Version 03.01.01 du 01/04/15  
Printed on the 17/11/15 at 17h20  
Vehicle : AA-000-AA  
Indicator : 03000

\*\*\*\*\* DELIVERY \*\*\*\*\*

Delivery nb 005

Compartment : 1  
Product : FOD  
Measurement nb1(EMA) : 01999 litres  
Measurement nb2(EMA) : 00633 litres  
Measurement nb3(EMA) : 01100 litres

Total Cpt 1 : 03732 litres

In case of dispute, the measurement  
results stored by the main  
indicating device provding proof



MU 7070 EN A  
FLEXICOMPT+ D25 MONO OR DUAL

This document is available at [www.alma-alma.fr](http://www.alma-alma.fr)

Page 22/23

## RELATED DOCUMENTS

GU 7070	User Guide
MV 5008	Verification Guide
FM 8000	Replacement of the backup batteries on the AFSEC and AFSEC+ electronic board
FM 8001	Diagnostic support for power supply failure
FM 8002	Diagnostic support for a display failure
FM 8003	Diagnostic support for DEB_0 or ZERO FLOW DEFAULT alarm
FM 8004	Diagnostic support for GAS or PRESENCE GAS alarm
FM 8005	Diagnostic support for METERING PROBLEM alarm
FM 8006	Diagnostic support for DATE AND TIME LOST alarm
FM 8007	Diagnostic support for MEMORY LOST or DEF MEMO alarm
FM 8010	Diagnostic support for EEPROM MEMORY LOST alarm
FM 8011	Configuration of jumpers and adjustment of metering thresholds on the AFSEC+ electronic board
FM 8510	Adjustment of a temperature chain in a MICROCOMPT+