







	<h2 style="margin: 0;">GUIDE D'UTILISATION</h2> <h3 style="margin: 0;">FUEL METERING SYSTEM</h3> <h3 style="margin: 0;">FMS OEM UTP WITH MPLS</h3>	<p style="margin: 0;">GU 7112 EN A</p> <p style="margin: 0;"><a href="http://www.alma.alma.fr">www.alma.alma.fr</a></p>
---	--	---

This document sketches out the main menus (for further information, please refer to operating manual MU 7112 EN)

#### USING THE BUTTONS

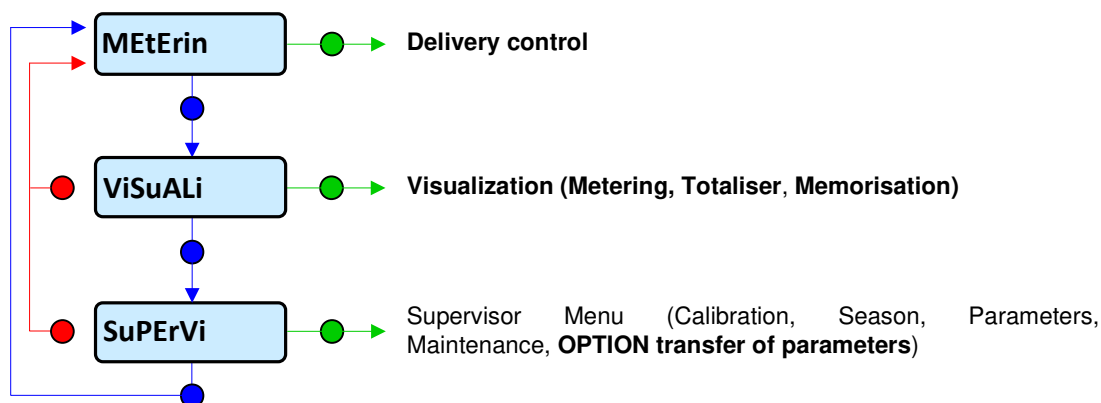
-  Come back to the previous stage ●
-  Choose the menu option ●  
 Display the delivery information
-  Validate the displayed option ●  
 Validate a fault
-  Light the display during 10 seconds



-  **NB1:** Since the CTD+ key is not ATEX, it must be used outside potentially explosive area
- NB2:** Do not plug the USB cable during data transfer.

# RUN A DELIVERY

## 1. PREPARE THE DELIVERY

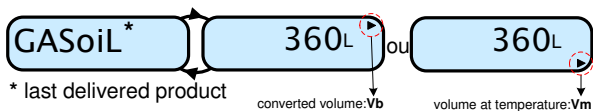

### ▲ DELIVERY AUTHORISATION

Appearance of the authorisation causes a display test and resets the volume.

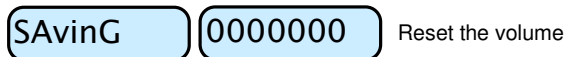

### ▲ CHOOSE THE PRODUCT

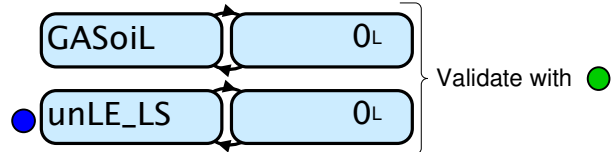

...

### ▲ CHOOSE THE DISTRIBUTION MODE ▲ with PRESET MODE

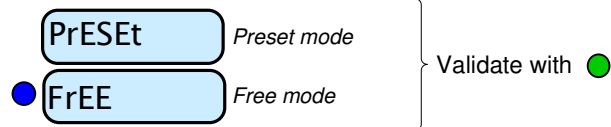

### ▲ SET THE VOLUME ▲ with PRESET MODE



- Change the blinking figure value
- Access to the following figure
- Validate

## 2. CARRY OUT THE DELIVERY



### CHECK THE CHOSEN PRODUCT

NOTE: The unit of flowrate and volume depends on the settings chosen.

### ▲ START THE DELIVERY

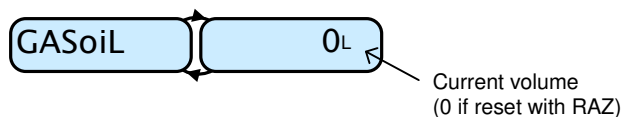

### ▲ DISPLAY THE DELIVERY INFORMATION

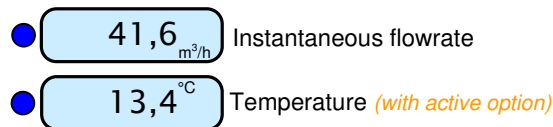

### ▶ APPEARANCE OF A FAULT AND DISPLAY OF AN ALARM

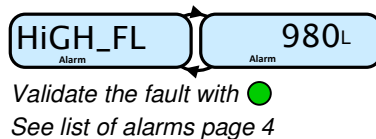

## The delivery may be interrupted by several situations

### ▶ INTENTIONAL INTERRUPTION OF THE DELIVERY

▼ The delivery may be interrupted at any time by closing the valve

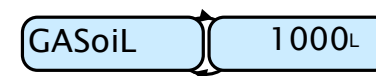

▼ Close the valve → End the delivery (§3)  
→ Continue delivery (§2)

## 3. FINISH THE DELIVERY

### ▲ DELIVERY AUTHORISATION

When the delivery authorisation is removed, the measurement is ended and recorded. Back to §1

### MEANING OF SYMBOLS

- ▲ Mandatory action
- ▲ Optional action (depends on configuration chosen)
- ▶ Event during delivery
- ▼ Action by operator

# DISPLAY/TRANSFER\* THE DELIVERY DATA

## VISUALIZATION OF THE LAST DELIVERY RESULTS - sub-menu **MEtErin**

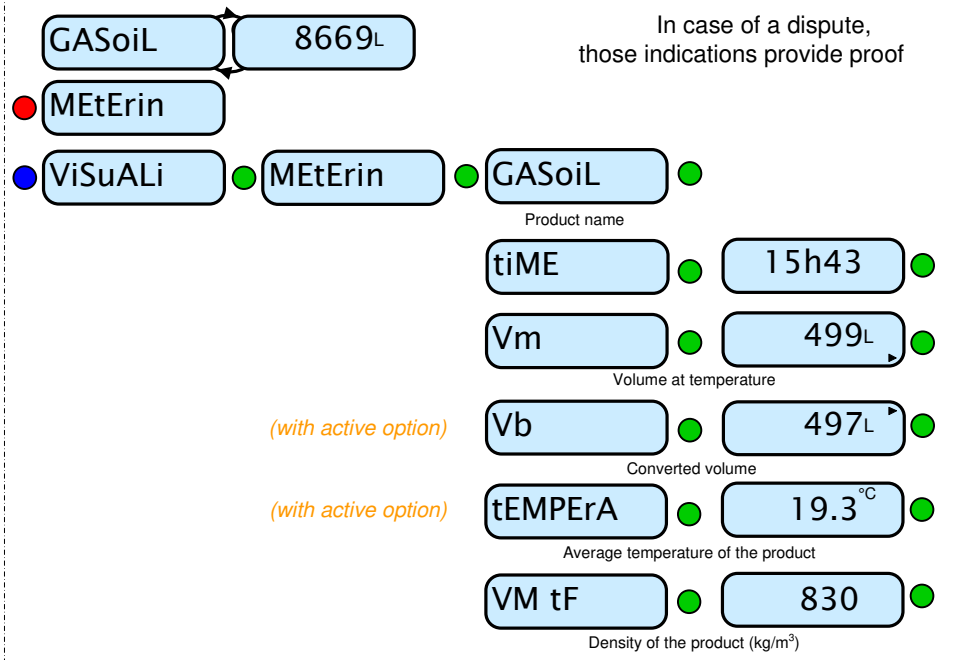

## VISUALIZATION OF ALL THE DELIVERY RESULTS - sub-menu **MEMoriS**

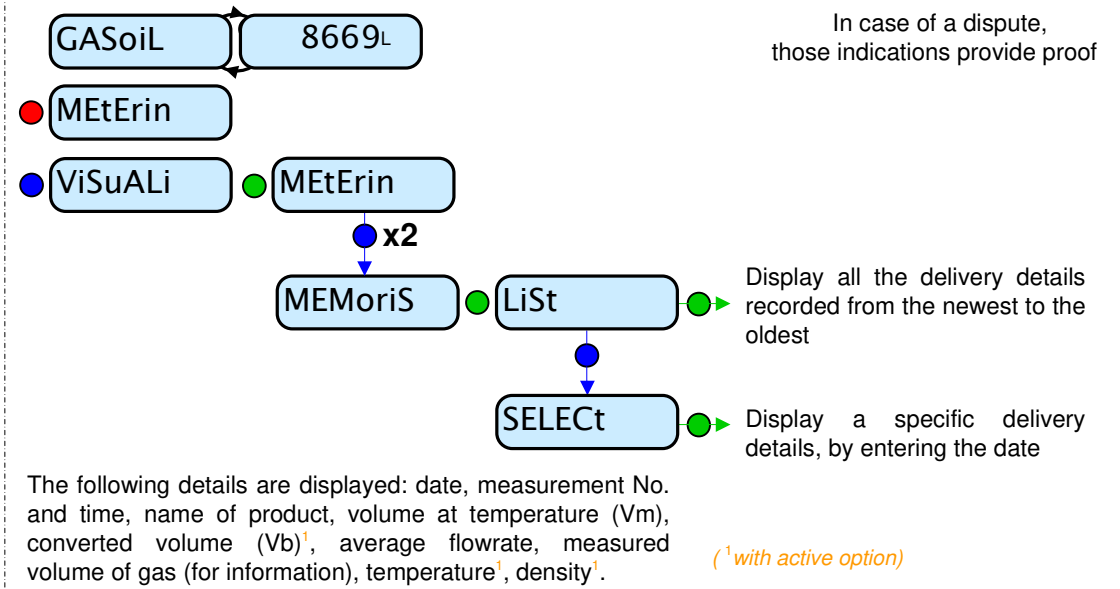

## VISUALIZATION OF THE TOTALISERS - sub-menu **totALiS**

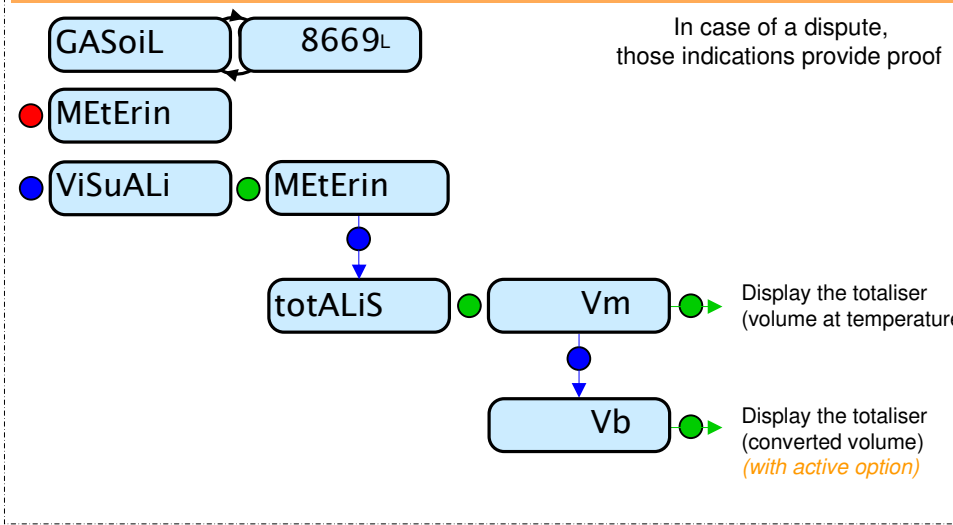

## \*OPTION KEY CTD+: TRANSFER MEASUREMENT DATA

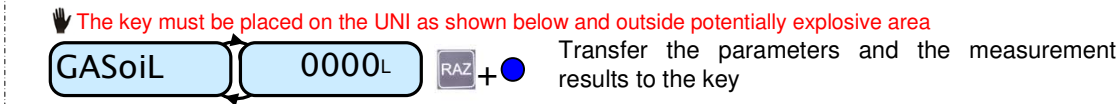

## \*OPTION KEY CTD+: TRANSFER MEASUREMENT DATA - sub-menu **trAnSFr**

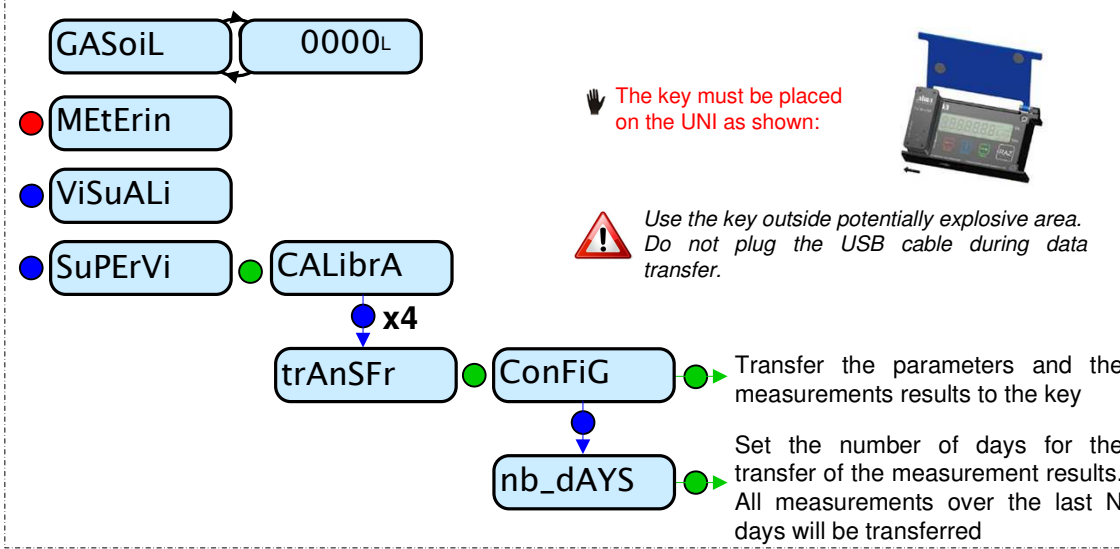

# LIST OF ALARMS

		DISPLAY	MEANING	ACTION
USER	MPLS	oVerFLo	Volume greater than 4 194 304 liters	Reset the device
		LoW_FLo	Flow rate less than the setting minimal flow rate	Check the hydraulic configuration and the flowing
		StoP	Intentional interruption of delivery	Stop delivery
		Author	The autorisation has been removed during pouring	The measurement is ended
		LEAK	Counting of a volume greater than or equal to 1 liter (metering off)	Acknowledge the alarm to end measurement
		dEFPrEd	Volume $\geq$ preset volume+1% the minimum quantity	Acknowledge the alarm
REPARATOR		FLoV_	Flow setting fault	Check the parameters
		FrEQ_	Frequency fault	Check the parameters
		COEFF_	Difference two coefficients is greater than 0,5%	Check the coefficients setup
		MEtEr	Problem of metering with the meter	Check the setup
		HiGH_FL	Flow rate greater than the setting maximal flowrate	Check the setup
		dAtE	Loss of date and time	Set date and time in metrological mode
		CoIL	Loss of pulse transmitter signal	Check the connection with the pulse transmitter
		tEMPErA	Temperature less than -20°C or greater than 50°C	Check the temperature sensor (measure and calibration)
		diSPLAY	LCD display fault	If steady alarm, substitution of the UNI
		doG	Fault with card	If steady alarm, substitution of the UNI
		ProGrAM	Error on the cheksum of the metrological data	If steady alarm, substitution of the UNI
		rAM	Saved memory fault	If steady alarm, substitution of the UNI
		MEMoriS	Bad writting into the memory	If steady alarm, substitution of the UNI
		FuLL	If a measurement result, not older than 3 months, is about to be erased	If steady alarm, substitution of the UNI
		MEtro_	Configuration loss	If steady alarm, substitution of the UNI
		bAttErY	Low battery	Substitution of the batteries
		totAL_	Totaliser fault	If steady alarm, substitution of the UNI
		dEF_MEM	Loss of backup data concerning the last measurement	If steady alarm, substitution of the UNI
dEF_CoM	Communication fault with IRDA link	Check the IRDA link		
rECEPt	Problem of communication protocol between the calculator-indicator UNI and the MPLS device	Check the compatibility of the software version of the MPLS device with the calculator-indicator UNI		